

EXPLOSION-PROOF TOOLS



沧州天龙防爆工具有限公司

CANGZHOU TIANLONG EXPLOSION-PROOF TOOLS CO.,LTD



诚/信/铸/就/品/牌 服/务/编/制/未/来

- 先进的设备
- 完善的检测
- 保证产品的完美品质

BRIEF

INTRODUCTION 企业简介

沧州天龙防爆工具有限公司是一家集研制、开发、生产和销售为一体的防爆工具专业制造商。主要致力于防爆工具、特种工具和防磁工具的制造。公司始建于1997年，坐落在河北省泊头市南付庄开发区，占地面积15000平方米，员工二百多人，我公司利用先进的生产设备和雄厚的技术力量为依托，以严格的生产管理和品质控制作保证，从原材料的选择到最后产品出厂都严格把关，确保了在激烈的行业竞争中始终以质量立于潮头。

我公司生产的防爆工具可以有效的防止工具与工作物之间相互摩擦撞击时产生的可燃性气体爆炸，确保人身和国家财产安全。该类工具主要产品类别有防爆扳手类、防爆套筒类、防爆钳子类、防爆螺丝刀类、防爆锯类、防爆锉类等，可以广泛用于石油、石化、化工、矿山、天然气、发电、制药、储运、制气、煤矿、冶金、油脂、造船等行业。防磁工具是在车间磁场环境特别强的情况下进行操作和维修工作必备的专用工具，包括防磁手柄类、防磁锤子类、防磁刀锹类等多个系列。同时我们还可以根据用户的不同需求定制各种特殊规格的工具。

公司所有产品都经国家专业防爆工具认证部门认证，并于2006年全面通过ISO9001国际质量管理体系认证。我们始终秉承“质量为本、客户至上、不断进取”的理念，以锲而不舍的进取心和孜孜不倦的探索精神，专心打造一流的防爆工具制造企业，努力开创沧州天龙防爆工具有限公司更加璀璨辉煌的明天！

Cangzhou tianlong explosion-proof tools Co.,Ltd. is a research and development, production and sales of professional manufacturer of explosion-proof tools. Committed to the main explosion-proof tools, special tools and tool manufacturing Magnetically-shielded.

Our company Founded in 1997, is located in Botou City of Hebei Province to pay Zhuang Development Zone, covers an area of 15,000 square meters, more than two hundred employees, our use of advanced production equipment and strong technical force based to a strict Production management and quality control as a guarantee from the choice of raw materials to final products are manufactured in strict checks to ensure that in the fierce competition in the industry has the quality to remain the forefront.

Produced the explosion-proof tools can be effective tools to prevent and complex work of the friction between the impact when the flammable gas explosion, and to ensure the personal safety of state property. The main categories of products such tools are explosion-proof type of wrench, sleeve-type explosion-proof, explosion-proof-type pliers, screwdriver-type explosion-proof, explosion-proof type of cut, explosion-proof, and other types of files can be widely used in the petroleum, petrochemical, chemical, mining, Natural gas, power generation, pharmaceuticals, transportation, gas, coal, metallurgy, oil, shipbuilding and other industries, Magnetically-shielded tools in the workshop environment, in particular strong magnetic field conditions necessary for the operation and maintenance of special tools, including the handle Magnetically-shielded category, Magnetically-shielded type of hammer, shovel-type knife Magnetically-shielded, and other family. At the same time, we can according to the different needs of a variety of special custom specifications.

All products are explosion-proof tools by national professional certification department certification, and in 2006 adopted a comprehensive ISO9001 international quality management system certification. We have always followed a policy of "quality-oriented, customer focus, continuous improvement," the idea of enterprise and perseverance to work hard to explore the spirit of focus on the explosion-proof tools to build first-class manufacturing companies, and strive to create a new explosion-proof tools Co.,Ltd. Cangzhou Dragons more Cui Can glorious tomorrow!

天龙防爆工具

专业制造商

TIANLONG



企业荣誉

DARES TO CHALLENGE



天龙防爆工具

专业制造商

TIANLONG



防爆工具技术参数：

镀青铜防爆工具防爆性能

标准代号：GBEX II C

硬度：HRC30-40

抗拉强度： $\delta b105-120\text{kgf/mm}^2$

磁性：0

高强度铝青铜防爆工具防爆性能

标准代号：GBEX II B

硬度：HRC20-30

抗拉强度： $\delta b75-85\text{kgf/mm}^2$



CONTENTS

目录

01	防爆扳手系列 Explosion-proof wrenches series	01
02	防爆套筒系列 Explosion-proof socket series	25
03	防爆钳子系列 Explosion-proof pliers series	35
04	防爆锤子系列 Explosion-proof series of hammer	41
05	防爆旋具系列 Explosion-proof screwdriver series	50
06	防爆撬凿系列 Explosion-proof pry iron series	53
07	防爆刀锯系列 Explosion-proof inadvertently series	60
08	防爆刷子系列 Explosion-proof brush series	65
09	防爆锹铲系列 Explosion-proof spade series	67
10	防爆其它系列 Other series explosion-proof	73
11	钢制工具系列 Steel tool series	85
12	防爆组合工具系列 Explosion-proof composite tools series	90

TIANLONG 天龙防爆工具
高精品质 全国领先品牌



防爆扳手系列

专业制造商

TIANLONG

TIANLONG



TL101 防爆两用扳手公制

Wrench,Combination



规格及主要技术参数

产品代号 Number	规格(S) mm	长度(L) mm	产品代号 Number	规格(S) mm	长度(L) mm	铍青铜 (Be-Cu)g	铝青铜 (Al-Cu)g
TL101-6	6	105	TL101A-8	5/16	105	22	20
TL101-7	7	105	TL101A-9	3/8	135	37	34
TL101-8	8	120	TL101A-10	13/32	135	37	34
TL101-9	9	120	TL101A-11	7/16	135	55	50
TL101-10	10	135	TL101A-13	1/2	150	55	50
TL101-11	11	135	TL101A-14	9/16	175	75	75
TL101-12	12	150	TL101A-15	19/32	175	75	70
TL101-13	13	150	TL101A-16	5/8	195	122	110
TL101-14	14	175	TL101A-17	11/16	195	122	110
TL101-15	15	175	TL101A-19	3/4	215	160	145
TL101-16	16	195	TL101A-20	25/32	230	155	140
TL101-17	17	195	TL101A-21	13/16	230	155	140
TL101-18	18	215	TL101A-22	7/8	245	210	190
TL101-19	19	215	TL101A-23	15/16	245	210	190
TL101-20	20	230	TL101A-24	31/32	265	225	200
TL101-21	21	230	TL101A-25	1	265	225	200
TL101-22	22	245	TL101A-27	1-1/16	290	250	220
TL101-23	23	245	TL101A-28	1-1/8	290	265	233
TL101-24	24	265	TL101A-30	1-3/16	320	260	230
TL101-25	25	265	TL101A-32	1-1/4	340	260	230
TL101-26	26	290	TL101A-33	1-5/16	360	420	380
TL101-27	27	290	TL101A-35	1-3/8	360	420	380
TL101-28	28	290	TL101A-36	1-7/16	360	500	450
TL101-29	29	320	TL101A-38	1-1/2	430	540	480
TL101-30	30	320	TL101A-40	1-9/16	430	560	500
TL101-32	32	340	TL101A-41	1-5/8	430	670	600
TL101-34	34	360	TL101A-43	1-11/16	480	850	750
TL101-36	36	360	TL101A-44	1-3/4	480	890	800
TL101-38	38	430	TL101A-50	2	520	1440	1300
TL101-41	41	430	TL101A-56	2-3/16	560	1440	1300
TL101-46	46	480	TL101A-60	2-3/8	595	1890	1700
TL101-50	50	520	TL101A-65	2-9/16	595	2220	2000
TL101-55	55	560	TL101A-67	2-5/8	595	2460	2230
TL101-60	60	595	TL101A-70	2-3/4	630	3300	2950
TL101-65	65	595				3250	2900
TL101-70	70	630				4550	4100

TL102-104防爆两用扳手套装

Wrench,Combination Set



规格及主要技术参数

产品代号 Number	规格(S) mm	铍青铜(Be-Cu) g	铝青铜(Al-Cu) g
TL102	8,10,12,14,17,19,22,24,27	1815	1655
TL103	8,10,12,14,17,19,22,24,27,30,32	3235	2955
TL104	8,10,12,13,14,16,17,19,22,24,27,30,32	3485	3175

TL101B 防爆加长两用扳手

Wrench,Combination Lengthen



规格及主要技术参数

产品代号 Number	规格(S) mm	长度(L) mm	铍青铜 (Be-Cu)g	铝青铜 (Al-Cu)g
TL101B-10	10	190	82	70
TL101B-12	12	210	82	70
TL101B-14	14	225	105	90
TL101B-17	17	280	163	140
TL101B-19	19	310	232	200
TL101B-22	22	350	302	260
TL101B-24	24	400	430	370
TL101B-27	27	450	580	500
TL101B-30	30	480	847	730
TL101B-32	32	500	1044	900
TL101B-36	36	550	1392	1200
TL101B-41	41	600	2320	2000
TL101B-46	46	640	3248	2800



TL101C 防爆高颈两用扳手

Wrench, combination offset

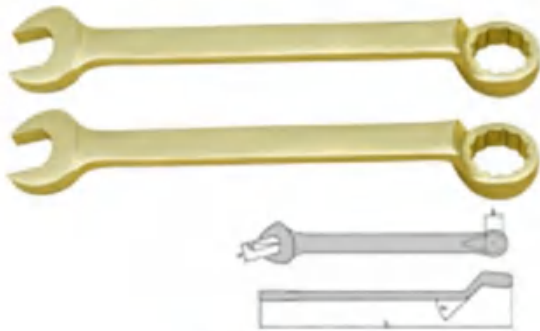

规格及主要技术参数

产品代号 Number	规格(S) mm	长度(L) mm	铍青铜(Be-Cu) g	铝青铜(Al-Cu) g
TL101C-17	17	240	230	210
TL101C-19	19	270	280	250
TL101C-21	21	290	380	340
TL101C-22	22	295	440	370
TL101C-24	24	320	460	390
TL101C-27	27	350	605	520
TL101C-30	30	390	720	640
TL101C-32	32	410	900	780

TL101D 防爆棘轮两用扳手

Wrench, Combination Ratchet

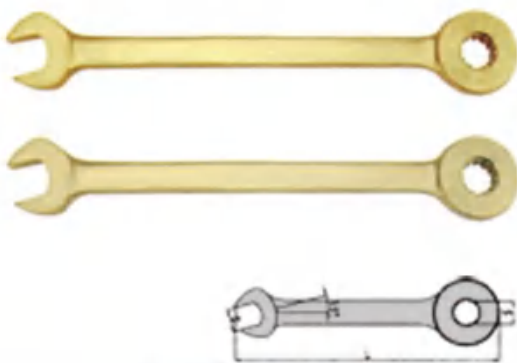

规格及主要技术参数

产品代号 Number	规格(S) mm	长度(L) mm	铍青铜(Be-Cu) g	铝青铜(Al-Cu) g
TL101D-17	17	220	250	225
TL101D-19	19	240	310	280
TL101D-22	22	270	420	380
TL101D-24	24	290	570	510
TL101D-27	27	315	750	675
TL101D-30	30	350	1000	900
TL101D-32	32	370	1155	1040

TL105 防爆双呆扳手公制

Wrench, Double Open End



规格及主要技术参数

产品代号 Number	规格(S) mm	长度(L) mm	产品代号 Number	规格(S) mm	长度(L) mm	铍青铜 (Be-Cu)g	铝青铜 (Al-Cu)g
TL105-0507	5.5*7	90	TL105A-0608	1*6*7/6	90	23	20
TL105-0607	6*7	92	TL105A-0809	5/16*3/8	100	25	22
TL105-0608	6*8	94	TL105A-0911	3/8*7/8	110	25	22
TL105-0709	7*9	96	TL105A-0913	3/8*1/2	115	28	25
TL105-0809	8*9	98	TL105A-1113	7/16*1/2	120	28	25
TL105-0810	8*10	100	TL105A-1315	1/2*9/16	130	34	31
TL105-0910	9*10	105	TL105A-1516	9/16*5/8	150	50	45
TL105-0911	9*11	110	TL105A-1618	5/8*11/8	160	50	45
TL105-1011	10*11	115	TL105A-1618	5/8*3/4	165	52	47
TL105-1012	10*12	120	TL105A-1819	11/16*3/4	170	60	55
TL105-1013	10*13	122	TL105A-1921	3/4*13/16	180	68	62
TL105-1014	10*14	124	TL105A-1922	3/4*7/8	185	68	62
TL105-1113	11*13	126	TL105A-2122	13/16*7/8	190	73	67
TL105-1213	12*13	128	TL105A-2224	7/8*15/16	210	73	67
TL105-1214	12*14	130	TL105A-2425	15/16*1	220	75	69
TL105-1317	13*17	140	TL105A-2527	1*1-1/16	230	110	100
TL105-1415	14*15	143	TL105A-2728	1-1/16*1-1/8	235	115	105
TL105-1417	14*17	150	TL105A-2830	1-1/8*1-3/16	245	120	110
TL105-1617	16*17	157	TL105A-3032	1-3/16*1-1/4	250	130	120
TL105-1618	16*18	163	TL105A-3235	1-1/4*1-3/8	300	145	130
TL105-1719	17*19	170	TL105A-3237	1-1/4*1-7/16	300	150	135
TL105-1721	17*21	173	TL105A-3338	1-5/16*1-1/2	330	185	165
TL105-1722	17*22	176	TL105A-3241	1-1/4*1-5/8	330	185	165
TL105-1819	18*19	179	TL105A-3538	1-3/8*1-1/2	330	200	180
TL105-1921	19*21	180	TL105A-3741	1-7/16*1-5/8	330	210	190
TL105-1922	19*22	185	TL105A-3843	1-1/2*1-11/16	330	220	200
TL105-1924	19*24	190	TL105A-4146	1-5/8*1-13/16	355	235	210
TL105-2022	20*22	195	TL105A-4144	1-5/8*1-3/4	355	250	225
TL105-2123	21*23	200	TL105A-4348	1-11/16*1-7/8	370	270	235
TL105-2126	21*26	205	TL105A-4651	1-13/16*1-7/8	370	275	245
TL105-2224	22*24	210	TL105A-4452	1-3/4*1-1/8	370	312	285
TL105-2227	22*27	215	TL105A-5156	1-3/4*1-3/8	385	320	292
TL105-2326	23*26	220	TL105A-5660	2-3/16*2-3/8	415	330	302
TL105-2426	24*26	225				345	310
TL105-2427	24*27	230				345	310
TL105-2430	24*30	233				365	330
TL105-2526	25*26	236				365	330
TL105-2629	26*29	240				465	420
TL105-2632	26*32	243				465	420
TL105-2729	27*29	246				485	430
TL105-2730	27*30	250				485	430
TL105-2732	27*32	255				610	549
TL105-2832	28*32	260				610	549
TL105-3032	30*32	265				610	549
TL105-3035	30*36	270				815	730
TL105-3234	32*34	270				815	730
TL105-3236	32*36	300				885	800
TL105-3436	34*36	300				885	800
TL105-3638	36*38	330				1350	1210
TL105-3641	36*41	330				1350	1210
TL105-3840	38*40	330				1350	1210
TL105-4146	41*46	355				1690	1530
TL105-4650	46*50	370				2050	1850
TL105-5055	50*55	385				2160	1950
TL105-5060	50*60	400				2488	2275
TL105-5560	55*60	415				2700	2450
TL105-6065	60*65	435				3950	3600



TL106-108 防爆双呆扳手套装

Wrench, Double Open End Set



规格及主要技术参数

产品代号 Number	规格(S) mm	铍青铜(Be-Cu) g	铝青铜(Al-Cu) g
TL106	8*10, 10*12, 12*14, 14*17, 17*19, 19*22, 22*24, 24*27, 30*32	2810	2570
TL107	8*10, 9*11, 10*12, 12*14, 14*17, 17*19, 19*22, 22*24, 24*27, 27*30, 30*32	3530	3230
TL108	5.5*7, 6*7, 8*10, 9*11, 10*12, 12*14, 14*17, 17*19, 19*22, 22*24, 24*27, 27*30, 30*32	3610	3295

TL105B 防爆90° 双头呆扳手

Wrench, Combination Double Open 90°



规格及主要技术参数

产品代号 Number	规格(S) mm	长度(L) mm	铍青铜(Be-Cu) g	铝青铜(Al-Cu) g
TL105B-04	4	70.0	8	7
TL105B-45	4.5	70.0	8	7
TL105B-05	5	78.0	8	7
TL105B-55	5.5	78.0	12	10
TL105B-06	6	78.0	12	10
TL105B-07	7	91.0	12	10
TL105B-08	8	96.0	17	15
TL105B-09	9	103.0	17	15
TL105B-10	10	105.0	23	20
TL105B-11	11	116.0	23	20
TL105B-12	12	116.0	40	35
TL105B-13	13	131.0	40	35
TL105B-14	14	131.0	40	35

TL109防爆双头梅花扳手

Wrench, Double Box Offset



规格及主要技术参数

产品代号 Number	规格(S) mm	长度(L) mm	产品代号 Number	规格(S) mm	长度(L) mm	铍青铜 (Be-Cu)g	铝青铜 (Al-Cu)g
TL109-0507	5.5*7	115	TL109A-0608	6*8	115	20	20
TL109-0607	6*7	115	TL109A-0809	8*10	125	25	23
TL109-0608	6*8	120	TL109A-0911	9*11	140	25	23
TL109-0709	7*9	130	TL109A-1113	10*12	155	50	46
TL109-0809	8*9	130	TL109A-1315	12*14	175	50	46
TL109-0810	8*10	130	TL109A-1516	14*17	215	55	50
TL109-0910	9*10	135	TL109A-1618	16*18	220	70	65
TL109-0911	9*11	140	TL109A-1819	18*19	245	70	65
TL109-1011	10*11	140	TL109A-1921	19*21	255	80	75
TL109-1012	10*12	140	TL109A-2122	21*22	275	85	78
TL109-1013	10*13	140	TL109A-2224	22*24	305	85	78
TL109-1014	10*14	140	TL109A-2425	24*25	310	120	110
TL109-1113	11*13	160	TL109A-2527	25*27	330	120	110
TL109-1213	12*13	160	TL109A-2729	27*29	330	120	110
TL109-1214	12*14	160	TL109A-2930	29*30	370	151	140
TL109-1415	14*15	200	TL109A-3032	30*32	370	205	180
TL109-1417	14*17	220	TL109A-3233	32*33	380	205	180
TL109-1617	16*17	220	TL109A-3335	33*35	410	220	202
TL109-1618	16*18	220	TL109A-3537	35*37	410	220	202
TL109-1719	17*19	250	TL109A-3741	37*41	450	225	205
TL109-1721	17*21	250	TL109A-3840	38*40	460	290	265
TL109-1722	17*22	250	TL109A-4146	41*46	470	290	265
TL109-1819	18*19	250	TL109A-4650	46*50	490	295	270
TL109-1921	19*21	280	TL109A-5055	50*55	510	310	280
TL109-1922	19*22	280	TL109A-5260	52*60	520	310	280
TL109-1924	19*24	310	TL109A-5560	55*60	530	355	320
TL109-2022	20*22	280	TL109A-6070	60*70	560	400	345
TL109-2123	21*23	285				405	360
TL109-2126	21*26	320				450	410
TL109-2224	22*24	310				455	415
TL109-2227	22*27	340				465	401
TL109-2326	23*26	340				520	475
TL109-2426	24*26	340				520	475
TL109-2427	24*27	340				520	475
TL109-2430	24*30	350				550	501
TL109-2528	25*28	350				580	530
TL109-2629	26*29	350				580	520
TL109-2632	26*32	370				640	570
TL109-2729	27*29	350				705	645
TL109-2730	27*30	360				705	645
TL109-2732	27*32	380				749	646
TL109-2832	28*32	380				805	736
TL109-3032	30*32	380				805	736
TL109-3036	30*36	395				1050	960
TL109-3234	32*34	400				1080	980
TL109-3235	32*35	405				1080	980
TL109-3236	32*36	405				1145	1030
TL109-3436	34*36	420				1165	1065
TL109-3541	35*41	426				1600	1465
TL109-3638	36*38	434				1600	1465
TL109-3641	36*41	445				1600	1465
TL109-3840	38*40	460				1699	1465
TL109-4146	41*46	470				2077	1905
TL109-4650	46*50	490				2530	2315
TL109-5055	50*55	510				2580	2360
TL109-5060	50*60	520				3002	2745
TL109-5560	55*60	530				3203	2905
TL109-6070	60*70	560				4105	3605



TL110-112防爆梅花扳手套装

Wrench, Double Box Offset Set



规格及主要技术参数

产品代号 Number	规格(S) mm	铍青铜(Be-Cu) g	铝青铜(Al-Cu) g
TL110	8*10, 10*12, 12*14, 14*17, 17*19, 19*22, 22*24, 24*27, 30*32	2815	2575
TL111	8*10, 9*11, 10*12, 12*14, 14*17, 17*19, 19*22, 22*24, 24*27, 27*30, 30*32	3585	3275
TL112	5.5*7, 6*7, 8*10, 9*11, 10*12, 12*14, 14*17, 17*19, 19*22, 22*24, 24*27, 27*30, 30*32	3630	3320

TL109B防爆平柄双头梅花扳手

Wrench, Double Box



规格及主要技术参数

产品代号 Number	规格(S) mm	长度(L) mm	铍青铜(Be-Cu) g	铝青铜(Al-Cu) g
TL109B-0810	8*10	115	32	29
TL109B-0911	9*11	125	37	34
TL109B-1012	10*12	140	55	48
TL109B-1214	12*14	145	70	62
TL109B-1417	14*17	165	100	90
TL109B-1719	17*19	185	132	120
TL109B-1922	19*22	200	180	165
TL109B-2224	22*24	220	240	215
TL109B-2427	24*27	255	320	280
TL109B-2730	27*30	280	385	340
TL109B-3032	30*32	295	465	415
TL109B-3036	30*36	330	600	545
TL109B-3641	36*41	365	935	845

TL113防爆德标单头呆扳手

Wrench, Single Open End



规格及主要技术参数

产品代号 Number	规格(S) mm	长度(L) mm	产品代号 Number	规格(S) mm	长度(L) mm	铍青铜 (Be-Cu)g	铝青铜 (Al-Cu)g
TL113-8	8	95	TL113A-8	5/16	95	40	35
TL113-9	9	95	TL113A-9	3/8	95	40	35
TL113-10	10	100	TL113A-10	13/32	100	50	45
TL113-11	11	100	TL113A-11	7/16	110	60	50
TL113-12	12	110	TL113A-13	1/2	110	65	60
TL113-13	13	110	TL113A-14	9/16	140	90	80
TL113-14	14	140	TL113A-15	19/32	145	95	85
TL113-15	15	145	TL113A-16	5/8	160	100	90
TL113-16	16	160	TL113A-18	11/16	160	100	90
TL113-17	17	160	TL113A-19	3/4	170	105	95
TL113-18	18	160	TL113A-20	25/32	190	125	110
TL113-19	19	170	TL113A-21	13/16	195	130	115
TL113-20	20	190	TL113A-22	7/8	195	160	145
TL113-21	21	195	TL113A-24	15/16	220	160	145
TL113-22	22	195	TL113A-25	31/32	220	170	152
TL113-23	23	220	TL113A-26	1	230	190	170
TL113-24	24	220	TL113A-27	1-1/16	240	190	170
TL113-25	25	230	TL113A-29	1-1/8	250	190	170
TL113-26	26	240	TL113A-30	1-3/16	260	190	170
TL113-27	27	240	TL113A-32	1-1/4	275	285	260
TL113-28	28	250	TL113A-33	1-5/16	275	285	260
TL113-29	29	260	TL113A-35	1-3/8	300	320	290
TL113-30	30	260	TL113A-37	1-7/16	310	320	290
TL113-32	32	275	TL113A-38	1-1/2	320	400	365
TL113-33	33	275	TL113A-39	1-9/16	345	400	365
TL113-34	34	290	TL113A-41	1-5/8	345	455	410
TL113-35	35	300	TL113A-43	1-11/16	345	455	410
TL113-36	36	310	TL113A-44	1-3/4	375	530	480
TL113-37	37	310	TL113A-46	1-13/16	375	530	480
TL113-38	38	320	TL113A-48	1-7/8	375	615	555
TL113-41	41	315	TL113A-51	2	410	615	555
TL113-42	42	345	TL113A-52	2-1/16	410	615	555
TL113-46	46	375	TL113A-54	2-1/8	450	950	860
TL113-47	47	375	TL113A-56	2-3/16	450	950	860
TL113-50	50	410	TL113A-57	2-1/4	490	1080	950
TL113-52	52	410	TL113A-59	2-5/16	490	1080	950
TL113-54	54	450	TL113A-60	2-3/8	490	1380	1200
TL113-55	55	450	TL113A-62	2-7/16	490	1380	1200
TL113-56	56	450	TL113A-64	2-1/2	490	1380	1200
TL113-58	58	490	TL113A-65	2-9/16	530	1950	1700
TL113-60	60	490	TL113A-67	2-5/8	530	1950	1700
TL113-63	63	490	TL113A-70	2-3/4	570	2250	2000
TL113-65	65	530	TL113A-71	2-13/16	570	2250	2000
TL113-67	67	550	TL113A-75	2-15/16	570	2850	2550
TL113-70	70	570	TL113A-76	3	610	2850	2550
TL113-71	71	570	TL113A-79	3-1/8	610	2850	2550
TL113-75	75	610	TL113A-83	3-1/4	650	3200	2800
TL113-77	77	610	TL113A-86	3-3/8	650	3200	2800
TL113-80	80	650	TL113A-89	3-1/2	680	3360	2900
TL113-82	82	650	TL113A-92	3-5/8	700	3360	2900
TL113-85	85	650	TL113A-95	3-3/4	740	3940	3400
TL113-88	88	680	TL113A-98	3-7/8	740	3940	3400
TL113-90	90	700				4100	3500
TL113-94	94	740				5800	4800
TL113-95	95	740				5800	4800
TL113-100	100	740				6840	5900



113B 防爆单头呆扳手

Wrench, Single Open End



规格及主要技术参数

产品代号 Number	规格(S) mm	长度(L) mm	产品代号 Number	规格(S) mm	长度(L) mm	铍青铜 (Be-Cu)g	铝青铜 (Al-Cu)g
TL113B-8	8	95	TL113C-8	5/16	95	44	39
TL113B-9	9	95	TL113C-9	3/8	95	44	39
TL113B-10	10	100	TL113C-10	13/32	100	55	50
TL113B-11	11	100	TL113C-11	7/16	110	66	55
TL113B-12	12	110	TL113C-13	1/2	110	72	66
TL113B-13	13	110	TL113C-14	9/16	140	99	88
TL113B-14	14	140	TL113C-15	19/32	145	105	94
TL113B-15	15	145	TL113C-16	5/8	160	110	99
TL113B-16	16	160	TL113C-18	11/16	160	110	99
TL113B-17	17	160	TL113C-19	3/4	170	116	105
TL113B-18	18	160	TL113C-20	25/32	190	138	121
TL113B-19	19	170	TL113C-21	13/16	195	143	127
TL113B-20	20	190	TL113C-22	7/8	195	176	160
TL113B-21	21	195	TL113C-24	15/16	220	176	160
TL113B-22	22	195	TL113C-25	31/32	220	187	167
TL113B-23	23	220	TL113C-26	1	230	209	187
TL113B-24	24	220	TL113C-27	1-1/16	240	209	187
TL113B-25	25	230	TL113C-29	1-1/8	250	209	187
TL113B-26	26	240	TL113C-30	1-3/16	260	209	187
TL113B-27	27	240	TL113C-32	1-1/4	275	314	286
TL113B-28	28	250	TL113C-33	1-5/16	275	314	286
TL113B-29	29	260	TL113C-35	1-3/8	300	352	319
TL113B-30	30	260	TL113C-37	1-7/16	310	352	319
TL113B-32	32	275	TL113C-38	1-1/2	320	440	402
TL113B-33	33	275	TL113C-39	1-9/16	345	440	402
TL113B-34	34	290	TL113C-41	1-5/8	345	501	451
TL113B-35	35	300	TL113C-43	1-11/16	345	501	451
TL113B-36	36	310	TL113C-44	1-3/4	375	583	528
TL113B-37	37	310	TL113C-46	1-13/16	375	583	528
TL113B-38	38	320	TL113C-48	1-7/8	375	677	611
TL113B-41	41	345	TL113C-51	2	410	677	611
TL113B-42	42	345	TL113C-52	2-1/16	410	677	611
TL113B-46	46	375	TL113C-54	2-1/8	450	1045	946
TL113B-47	47	375	TL113C-56	2-3/16	450	1045	946
TL113B-50	50	410	TL113C-57	2-1/4	490	1188	1045
TL113B-52	52	410	TL113C-59	2-5/16	490	1188	1045
TL113B-54	54	450	TL113C-60	2-3/8	490	1518	1320
TL113B-55	55	450	TL113C-62	2-7/16	490	1518	1320
TL113B-56	56	450	TL113C-64	2-1/2	490	1518	1320
TL113B-58	58	490	TL113C-65	2-9/16	530	2145	1870
TL113B-60	60	490	TL113C-67	2-5/8	530	2145	1870
TL113B-63	63	490	TL113C-70	2-3/4	570	2475	2200
TL113B-65	65	530	TL113C-71	2-13/16	570	2475	2200
TL113B-67	67	550	TL113C-75	2-15/16	570	3135	2805
TL113B-70	70	570	TL113C-76	3	610	3135	2805
TL113B-71	71	570	TL113C-79	3-1/8	610	3135	2805
TL113B-75	75	610	TL113C-83	3-1/4	650	3520	3080
TL113B-77	77	610	TL113C-86	3-3/8	650	3520	3080
TL113B-80	80	650	TL113C-89	3-1/2	680	3696	3190
TL113B-82	82	650	TL113C-92	3-5/8	700	3696	3190
TL113B-85	85	650	TL113C-95	3-3/4	740	4344	3740
TL113B-88	88	680	TL113C-98	3-7/8	740	4344	3740
TL113B-90	90	700				4510	3850
TL113B-94	94	740				6380	5280
TL113B-95	95	740				6380	5280
TL113B-100	100	740				7524	6490

TL113D 防爆加长单头呆扳手15° 45° 90°

Wrench, Single Open End Lengthen



规格及主要技术参数

产品代号 Number	规格(S) mm	长度(L) mm	铍青铜(Be-Cu) g	铝青铜(Al-Cu) g
TL113D-22	22	320	522	450
TL113D-23	23	320	522	450
TL113D-24	24	350	696	600
TL113D-25	25	350	696	600
TL113D-26	26	380	986	850
TL113D-27	27	380	986	850
TL113D-28	28	420	1160	1000
TL113D-29	29	420	1160	1000
TL113D-30	30	420	1160	1000
TL113D-32	32	450	1160	1000
TL113D-33	33	450	1160	1000
TL113D-34	34	450	1160	1000
TL113D-35	35	500	1624	1400
TL113D-36	36	500	1624	1400
TL113D-37	37	500	1624	1400
TL113D-38	38	500	1624	1400
TL113D-41	41	550	2088	1800
TL113D-42	42	550	2088	1800
TL113D-46	46	600	2900	2500
TL113D-47	47	600	2900	2500
TL113D-50	50	660	3712	3200
TL113D-52	52	660	3712	3200
TL113D-54	54	660	5104	4400
TL113D-55	55	730	5104	4400
TL113D-56	56	730	5104	4400
TL113D-58	58	800	6496	5600
TL113D-60	60	800	6496	5600

TL114 防爆德标单头梅花扳手

Wrench, Single Box



规格及主要技术参数

产品代号 Number	规格(S) mm	长度(L) mm	产品代号 Number	规格(S) mm	长度(L) mm	铍青铜 (Be-Cu)g	铝青铜 (Al-Cu)g
TL114-8	8	110	TL114A-11	7/16	130	40	35
TL114-10	10	120	TL114A-13	1/2	130	50	45
TL114-12	12	130	TL114A-14	9/16	140	65	60
TL114-13	13	130	TL114A-15	19/32	140	90	80
TL114-14	14	140	TL114A-16	5/8	155	90	80
TL114-15	15	140	TL114A-18	11/16	155	90	80
TL114-16	16	155	TL114A-19	3/4	170	105	90
TL114-17	17	155	TL114A-20	25*32	190	105	90
TL114-18	18	155	TL114A-21	13/16	190	130	95
TL114-19	19	170	TL114A-22	7/8	190	130	95
TL114-20	20	190	TL114A-24	15/16	215	150	135
TL114-21	21	190	TL114A-25	31/32	215	175	150
TL114-22	22	190	TL114A-26	1	215	175	150
TL114-23	23	215	TL114A-27	1-1/16	230	175	150
TL114-24	24	215	TL114A-29	1-1/8	255	220	200
TL114-25	25	215	TL114A-30	1-3/16	255	220	200
TL114-26	26	230	TL114A-32	1-1/4	265	270	245
TL114-27	27	230	TL114A-33	1-5/16	395	270	245
TL114-28	28	230	TL114A-35	1-3/8	395	270	245
TL114-29	29	255	TL114A-37	1-7/16	395	370	335
TL114-30	30	255	TL114A-38	1-1/2	310	370	335
TL114-32	32	265	TL114A-39	1-9/16	330	425	385
TL114-33	33	265	TL114A-41	1-5/8	330	425	385
TL114-34	34	295	TL114A-43	1-11/16	330	550	500
TL114-35	35	295	TL114A-44	1-3/4	365	550	500
TL114-36	36	295	TL114A-46	1-13/16	365	550	500
TL114-37	37	295	TL114A-48	1-7/8	365	550	500
TL114-38	38	310	TL114A-51	2	400	825	750
TL114-41	41	330	TL114A-52	2-1/16	400	825	750
TL114-42	42	330	TL114A-54	2-1/8	445	825	750
TL114-46	46	365	TL114A-56	2-3/16	445	1120	1010
TL114-47	47	365	TL114A-57	2-1/4	475	1270	1150
TL114-50	50	400	TL114A-59	2-5/16	475	1270	1150
TL114-52	52	400	TL114A-60	2-3/8	475	1270	1150
TL114-54	54	445	TL114A-62	2-7/16	510	1590	1440
TL114-55	55	445	TL114A-64	2-1/2	510	1590	1440
TL114-56	56	445	TL114A-65	2-9/16	510	1590	1440
TL114-58	58	475	TL114A-70	2-3/4	555	1850	1680
TL114-60	60	475	TL114A-75	2-15/16	590	1850	1680
TL114-63	63	510	TL114A-76	3	590	2060	1875
TL114-65	65	510	TL114A-79	3-1/8	630	2060	1875
TL114-67	67	555	TL114A-86	3-3/8	650	2530	2300
TL114-70	70	555	TL114A-89	3-1/2	700	2530	2300
TL114-71	71	555	TL114A-95	3-3/4	740	2530	2300
TL114-75	75	590				2700	2450
TL114-77	77	590				2900	2155
TL114-80	80	630				3400	2930
TL114-82	82	630				3400	2930
TL114-85	85	650				4000	3440
TL114-88	88	700				4500	3880
TL114-90	90	700				4500	3880
TL114-94	94	740				5000	4310
TL114-95	95	740				5000	4310

TL114B 防爆单头梅花扳手

Wrench, Single Box



规格及主要技术参数

产品代号 Number	规格(S) mm	长度(L) mm	产品代号 Number	规格(S) mm	长度(L) mm	铍青铜 (Be-Cu)g	铝青铜 (Al-Cu)g
TL114B-8	8	110	TL114C-11	7/16	130	44	39
TL114B-10	10	120	TL114C-13	1/2	130	55	50
TL114B-12	12	130	TL114C-14	9/16	140	72	66
TL114B-13	13	130	TL114C-15	19/32	140	99	88
TL114B-14	14	140	TL114C-16	5/8	155	99	88
TL114B-15	15	140	TL114C-18	11/16	155	99	88
TL114B-16	16	155	TL114C-19	3/4	170	116	99
TL114B-17	17	155	TL114C-20	25*32	190	116	99
TL114B-18	18	155	TL114C-21	13/16	190	143	105
TL114B-19	19	170	TL114C-22	7/8	190	143	105
TL114B-20	20	190	TL114C-24	15/16	215	165	149
TL114B-21	21	190	TL114C-25	31/32	215	193	165
TL114B-22	22	190	TL114C-26	1	215	193	165
TL114B-23	23	215	TL114C-27	1-1/16	230	193	165
TL114B-24	24	215	TL114C-29	1-1/8	255	242	220
TL114B-25	25	215	TL114C-30	1-3/16	255	242	220
TL114B-26	26	230	TL114C-32	1-1/4	265	297	270
TL114B-27	27	230	TL114C-33	1-5/16	395	297	270
TL114B-28	28	230	TL114C-35	1-3/8	395	297	270
TL114B-29	29	255	TL114C-37	1-7/16	395	407	369
TL114B-30	30	255	TL114C-38	1-1/2	310	407	369
TL114B-32	32	265	TL114C-39	1-9/16	330	468	424
TL114B-33	33	265	TL114C-41	1-5/8	330	468	424
TL114B-34	34	295	TL114C-43	1-11/16	330	605	550
TL114B-35	35	295	TL114A-44	1-3/4	365	605	550
TL114B-36	36	295	TL114C-46	1-13/16	365	605	550
TL114B-37	37	295	TL114C-48	1-7/8	365	605	550
TL114B-38	38	310	TL114C-51	2	400	908	825
TL114B-41	41	330	TL114C-52	2-1/16	400	908	825
TL114B-42	42	330	TL114C-54	2-1/8	445	908	825
TL114B-46	46	365	TL114C-56	2-3/16	445	1232	1111
TL114B-47	47	365	TL114C-57	2-1/4	475	1397	1265
TL114B-50	50	400	TL114C-59	2-5/16	475	1397	1265
TL114B-52	52	400	TL114C-60	2-3/8	475	1397	1265
TL114B-54	54	445	TL114C-62	2-7/16	510	1749	1584
TL114B-55	55	445	TL114C-64	2-1/2	510	1749	1584
TL114B-56	56	445	TL114C-65	2-9/16	510	1749	1584
TL114B-58	58	475	TL114C-70	2-3/4	555	2035	1848
TL114B-60	60	475	TL114C-75	2-15/16	590	2035	1848
TL114B-63	63	510	TL114C-76	3	590	2266	2063
TL114B-65	65	510	TL114C-79	3-1/8	630	2266	2063
TL114B-67	67	555	TL114C-86	3-3/8	650	2780	2530
TL114B-70	70	555	TL114C-89	3-1/2	700	2780	2530
TL114B-71	71	555	TL114C-95	3-3/4	740	2780	2530
TL114B-75	75	590				2970	2695
TL114B-77	77	590				3190	2371
TL114B-80	80	630				3740	3223
TL114B-82	82	630				3740	3223
TL114B-85	85	650				4400	3784
TL114B-88	88	700				4950	4268
TL114B-90	90	700				4950	4268
TL114B-94	94	740				5500	4741
TL114B-95	95	740				5500	4741

TL115 防爆弯柄呆扳手

Wrench, Bent Open End



规格及主要技术参数

产品代号 Number	规格(S) mm	长度(L) mm	铍青铜(Be-Cu) g	铝青铜(Al-Cu) g
TL115-17	17	125	125	115
TL115-18	18	125	180	165
TL115-19	19	125	180	165
TL115-21	21	135	250	230
TL115-22	22	135	250	230
TL115-24	24	150	255	235
TL115-27	27	175	380	350
TL115-30	30	190	490	450
TL115-32	32	190	590	545
TL115-34	34	200	720	660
TL115-36	36	210	850	780
TL115-38	38	230	1090	1005
TL115-41	41	230	1090	1005
TL115-46	46	250	1340	1225
TL115-50	50	275	1615	1480
TL115-55	55	305	2135	1955
TL115-60	60	315	2730	2350
TL115-65	65	335	3250	2800

TL116 弯柄单头梅花扳手

Wrench, Single Bent Box



规格及主要技术参数

产品代号 Number	规格(S) mm	长度(L) mm	铍青铜(Be-Cu) g	铝青铜(Al-Cu) g
TL116-17	17	125	160	145
TL116-18	18	125	195	190
TL116-19	19	125	195	190
TL116-21	21	135	205	180
TL116-22	22	135	205	180
TL116-24	24	160	330	295
TL116-27	27	175	315	275
TL116-30	30	190	480	430
TL116-32	32	190	455	410
TL116-34	34	210	650	580
TL116-36	36	210	650	580
TL116-38	38	225	830	740
TL116-41	41	225	810	720
TL116-46	46	240	1230	1100
TL116-50	50	255	1400	1255
TL116-55	55	270	1930	1720
TL116-60	60	285	2100	1900
TL116-65	65	300	2360	2135

TL117 防爆敲击梅花扳手

Wrench, Striking Box



规格及主要技术参数

产品代号 Number	规格(S) mm	长度(L) mm	产品代号 Number	规格(S) mm	长度(L) mm	铍青铜 (Be-Cu)g	铝青铜 (Al-Cu)g
TL117-17	17	145	TL117A-19	3/4	145	210	190
TL117-19	19	145	TL117A-22	7/8	165	200	180
TL117-22	22	165	TL117A-24	15/16	165	245	220
TL117-24	24	165	TL117A-26	1	165	235	210
TL117-25	25	165	TL117A-27	1-1/16	175	235	210
TL117-26	26	175	TL117A-29	1-1/8	175	350	315
TL117-27	27	175	TL117A-30	1-3/16	185	350	315
TL117-28	28	175	TL117A-32	1-1/4	185	350	315
TL117-29	29	185	TL117A-33	1-5/16	200	475	430
TL117-30	30	185	TL117A-35	1-3/8	200	475	430
TL117-32	32	185	TL117A-37	1-7/16	200	465	420
TL117-33	33	200	TL117A-38	1-1/2	200	540	490
TL117-34	34	200	TL117A-39	1-9/16	200	540	490
TL117-35	35	200	TL117A-41	1-5/8	225	580	520
TL117-36	36	200	TL117A-43	1-11/16	225	580	520
TL117-37	37	200	TL117A-44	1-3/4	235	580	520
TL117-38	38	200	TL117A-46	1-13/16	235	680	620
TL117-41	41	225	TL117A-48	1-7/8	235	755	680
TL117-42	42	225	TL117A-51	2	250	755	680
TL117-46	46	235	TL117A-52	2-1/16	265	990	890
TL117-47	47	235	TL117A-54	2-1/8	265	990	890
TL117-50	50	250	TL117A-56	2-3/16	265	1145	1030
TL117-52	52	265	TL117A-57	2-1/4	265	1145	1030
TL117-54	54	265	TL117A-59	2-5/16	275	1440	1300
TL117-55	55	265	TL117A-60	2-3/8	275	1440	1300
TL117-56	56	265	TL117A-62	2-7/16	275	1440	1300
TL117-58	58	275	TL117A-64	2-1/2	298	1620	1450
TL117-60	60	275	TL117A-65	2-9/16	298	1620	1450
TL117-63	63	298	TL117A-67	2-5/8	298	1995	1800
TL117-65	65	298	TL117A-70	2-3/4	320	1995	1800
TL117-67	67	320	TL117A-71	2-13/16	320	2435	2200
TL117-70	70	320	TL117A-75	2-15/16	326	2435	2200
TL117-71	71	320	TL117A-76	3	326	2435	2200
TL117-75	75	326	TL117A-79	3-1/8	350	3010	2720
TL117-77	77	326	TL117A-83	3-1/4	350	3600	3250
TL117-80	80	350	TL117A-86	3-3/8	355	3600	3250
TL117-82	82	350	TL117A-89	3-1/2	390	3600	3250
TL117-85	85	355	TL117A-92	3-5/8	390	4330	3915
TL117-88	88	390	TL117A-95	3-3/4	390	5200	4700
TL117-90	90	390	TL117A-96	3-7/8	420	5200	4700
TL117-94	94	390	TL117A-102	4	420	5450	4920
TL117-95	95	390	TL117A-102	4-1/8	420	5450	4920
TL117-100	100	420	TL117A-110	4-5/16	450	6750	6100
TL117-105	105	420	TL117A-116	4-9/16	480	7000	6320
TL117-110	110	450	TL117A-119	4-11/16	480	9130	8250
TL117-115	115	480	TL117A-125	4-15/16	540	10500	9200
TL117-120	120	480	TL117A-130	5-1/8	510	11000	9930
TL117-125	125	510	TL117A-137	5-3/8	520	12600	11400
TL117-130	130	510	TL117A-145	5-11/16	520	12610	11400
TL117-135	135	520	TL117A-152	6	565	13000	11750
TL117-145	145	520				13000	11750
TL117-150	150	565				14500	13100
TL117-155	155	565				16000	13790



TL117B 防爆敲击梅花扳手

Wrench, Striking Box

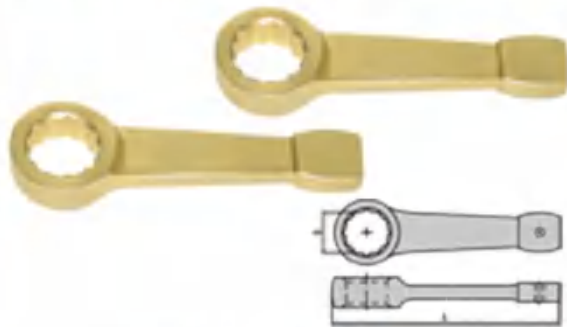

规格及主要技术参数

产品代号 Number	规格(S) mm	长度(L) mm	产品代号 Number	规格(S) mm	长度(L) mm	铍青铜 (Be-Cu)g	铝青铜 (Al-Cu)g
TL117B-17	17	145	TL117C-19	3/4	145	105	95
TL117B-19	19	145	TL117C-22	7/8	165	135	125
TL117B-22	22	165	TL117C-24	15/16	165	192	185
TL117B-24	24	165	TL117C-26	1	165	270	250
TL117B-25	25	165	TL117C-27	1-1/16	175	350	320
TL117B-26	26	175	TL117C-29	1-1/8	175	350	320
TL117B-27	27	175	TL117C-30	1-3/16	185	350	320
TL117B-28	28	175	TL117C-32	1-1/4	185	460	420
TL117B-29	29	185	TL117C-33	1-5/16	200	460	420
TL117B-30	30	185	TL117C-35	1-3/8	200	460	420
TL117B-32	32	185	TL117C-37	1-7/16	200	610	555
TL117B-33	33	200	TL117C-38	1-1/2	200	690	630
TL117B-34	34	200	TL117C-39	1-9/16	200	690	630
TL117B-35	35	200	TL117C-41	1-5/8	225	780	710
TL117B-36	36	200	TL117C-43	1-11/16	225	780	710
TL117B-37	37	200	TL117C-44	1-3/4	235	875	805
TL117B-38	38	200	TL117C-46	1-13/16	235	875	805
TL117B-41	41	225	TL117C-48	1-7/8	235	985	902
TL117B-42	42	225	TL117C-51	2	250	985	902
TL117B-46	46	235	TL117C-52	2-1/16	265	1275	1160
TL117B-47	47	235	TL117C-54	2-1/8	265	1275	1160
TL117B-50	50	250	TL117C-56	2-3/16	265	1545	1410
TL117B-52	52	265	TL117C-57	2-1/4	265	1545	1410
TL117B-54	54	265	TL117C-59	2-5/16	275	1720	1560
TL117B-55	55	265	TL117C-60	2-3/8	275	1720	1560
TL117B-56	56	265	TL117C-62	2-7/16	275	1720	1560
TL117B-58	58	275	TL117C-64	2-1/2	298	2080	1880
TL117B-60	60	275	TL117C-65	2-9/16	298	2080	1880
TL117B-63	63	298	TL117C-67	2-5/8	298	2440	2202
TL117B-65	65	298	TL117C-70	2-3/4	320	2440	2202
TL117B-67	67	320	TL117C-71	2-13/16	320	2440	2202
TL117B-70	70	320	TL117C-75	2-15/16	326	2435	2470
TL117B-71	71	320	TL117C-76	3	326	2435	2470
TL117B-75	75	326	TL117C-79	3-1/8	350	3190	2905
TL117B-77	77	326	TL117C-83	3-1/4	350	3190	2905
TL117B-80	80	350	TL117C-86	3-3/8	355	3485	3160
TL117B-82	82	350	TL117C-89	3-1/2	390	3485	3160
TL117B-85	85	355	TL117C-92	3-5/8	390	3990	3650
TL117B-88	88	390	TL117C-95	3-3/4	390	4350	3960
TL117B-90	90	390	TL117C-98	3-7/8	420	4350	3960
TL117B-94	94	390	TL117C-102	4	420	5046	4560
TL117B-95	95	390	TL117C-102	4-1/8	420	5046	4560
TL117B-100	100	420	TL117C-110	4-5/16	450	5630	5125
TL117B-105	105	420	TL117C-116	4-9/16	480	6250	5690
TL117B-110	110	450	TL117C-119	4-11/16	480	6750	6100
TL117B-115	115	480	TL117C-125	4-15/16	540	7078	6102
TL117B-120	120	480	TL117C-130	5-1/8	510	7405	6735
TL117B-125	125	510	TL117C-137	5-3/8	520	7655	7023
TL117B-130	130	510	TL117C-145	5-11/16	520	7905	7205
TL117B-135	135	520	TL117C-152	6	565	8584	7400
TL117B-145	145	520				9965	8590
TL117B-150	150	565				10440	9000
TL117B-155	155	565				10788	9300

TL118 防爆敲击呆扳手

Wrench, Striking Open



规格及主要技术参数

产品代号 Number	规格(S) mm	长度(L) mm	产品代号 Number	规格(S) mm	长度(L) mm	铍青铜 (Be-Cu)g	铝青铜 (Al-Cu)g
TL118-17	17	125	TL118A-17	11/16	125	150	135
TL118-19	19	125	TL118A-19	3/4	125	150	135
TL118-22	22	135	TL118A-22	7/8	135	195	175
TL118-24	24	150	TL118A-24	15/16	150	245	220
TL118-27	27	165	TL118A-27	1-1/16	165	335	300
TL118-28	28	165	TL118A-29	1-1/8	165	435	390
TL118-29	29	180	TL118A-30	1-3/16	180	435	390
TL118-30	30	180	TL118A-32	1-1/4	190	435	390
TL118-32	32	190	TL118A-33	1-5/16	200	515	460
TL118-33	33	190	TL118A-35	1-3/8	210	515	460
TL118-34	34	200	TL118A-37	1-7/16	210	800	730
TL118-35	35	210	TL118A-38	1-1/2	230	800	730
TL118-36	36	210	TL118A-39	1-9/16	230	800	730
TL118-37	37	210	TL118A-41	1-5/8	230	800	730
TL118-38	38	230	TL118A-43	1-11/16	230	955	860
TL118-41	41	230	TL118A-44	1-3/4	230	955	860
TL118-42	42	230	TL118A-46	1-13/16	240	955	860
TL118-46	46	240	TL118A-48	1-7/8	240	1225	1100
TL118-47	47	240	TL118A-51	2	255	1560	1420
TL118-50	50	255	TL118A-52	2-1/16	255	1560	1420
TL118-52	52	255	TL118A-54	2-1/8	255	1657	1429
TL118-54	54	272	TL118A-56	2-3/16	275	1850	1680
TL118-55	55	275	TL118A-57	2-1/4	275	1850	1680
TL118-56	56	275	TL118A-59	2-5/16	290	1850	1680
TL118-58	58	290	TL118A-60	2-3/8	290	2190	1970
TL118-60	60	290	TL118A-62	2-7/16	290	2190	1970
TL118-63	63	307	TL118A-64	2-1/2	290	3060	2780
TL118-65	65	307	TL118A-65	2-9/16	307	3060	2780
TL118-67	67	307	TL118A-67	2-5/8	325	4030	3660
TL118-70	70	325	TL118A-70	2-3/4	325	4030	3660
TL118-75	75	343	TL118A-71	2-13/16	325	4200	3800
TL118-80	80	360	TL118A-75	2-15/16	343	5650	5130
TL118-85	85	380	TL118A-76	3	343	6000	5400
TL118-90	90	400	TL118A-79	3-1/8	360	7800	7050
TL118-95	95	400	TL118A-83	3-1/4	360	7730	7000
TL118-100	100	430	TL118A-86	3-3/8	380	11600	10500
TL118-105	105	430	TL118A-89	3-1/2	380	12550	10819
TL118-110	110	465	TL118A-92	3-5/8	400	13500	12000
TL118-115	115	465	TL118A-95	3-3/4	400	14651	12630
TL118-120	120	465	TL118A-98	3-7/8	400	15196	13100
TL118-125	125	500	TL118A-102	4	430	15869	13680
TL118-130	130	500	TL118A-105	4-1/8	430	16507	14230
TL118-135	135	520	TL118A-110	4-5/16	430	17134	14770
TL118-145	145	550	TL118A-116	4-9/16	465	17635	15200
TL118-150	150	550	TL118A-119	4-11/16	465	18317	15790
TL118-155	155	565	TL118A-125	4-15/16	500	18908	16300
			TL118A-137	5-3/8	520	19500	16810
			TL118A-152	6	550	20126	17350



TL118B 防爆敲击呆扳手

Wrench, Striking Open



规格及主要技术参数

产品代号 Number	规格(S) mm	长度(L) mm	产品代号 Number	规格(S) mm	长度(L) mm	铍青铜 (Be-Cu)g	铝青铜 (Al-Cu)g
TL118B-17	17	125	TL118C-17	11/16	125	133	120
TL118B-19	19	125	TL118C-19	3/4	125	172	155
TL118B-22	22	135	TL118C-22	7/8	135	252	230
TL118B-24	24	150	TL118C-24	15/16	150	305	275
TL118B-27	27	165	TL118C-27	1-1/16	165	385	350
TL118B-28	28	165	TL118C-29	1-1/8	165	515	470
TL118B-29	29	180	TL118C-30	1-3/16	180	515	470
TL118B-30	30	180	TL118C-32	1-1/4	190	515	470
TL118B-32	32	190	TL118C-33	1-5/16	200	585	535
TL118B-33	33	190	TL118C-35	1-3/8	210	585	535
TL118B-34	34	200	TL118C-37	1-7/16	210	851	780
TL118B-35	35	210	TL118C-38	1-1/2	230	851	780
TL118B-36	36	210	TL118C-39	1-9/16	230	851	780
TL118B-37	37	210	TL118C-41	1-5/8	230	1055	965
TL118B-38	38	230	TL118C-43	1-11/16	230	1055	965
TL118B-41	41	230	TL118C-44	1-3/4	230	1055	965
TL118B-42	42	230	TL118C-46	1-13/16	240	1055	965
TL118B-46	46	240	TL118C-48	1-7/8	240	1245	1140
TL118B-47	47	240	TL118C-51	2	255	1580	1445
TL118B-50	50	255	TL118C-52	2-1/16	255	1580	1445
TL118B-52	52	255	TL118C-54	2-1/8	255	1733	1590
TL118B-54	54	272	TL118C-56	2-3/16	275	1865	1705
TL118B-55	55	275	TL118C-57	2-1/4	275	1865	1705
TL118B-56	56	275	TL118C-59	2-5/16	290	2045	1877
TL118B-58	58	290	TL118C-60	2-3/8	290	2205	2015
TL118B-60	60	290	TL118C-62	2-7/16	290	2205	2015
TL118B-63	63	307	TL118C-64	2-1/2	290	3060	2805
TL118B-65	65	307	TL118C-65	2-9/16	307	3060	2805
TL118B-67	67	307	TL118C-67	2-5/8	325	3620	3310
TL118B-70	70	325	TL118C-70	2-3/4	325	3620	3310
TL118B-75	75	343	TL118C-71	2-13/16	325	3905	3570
TL118B-80	80	360	TL118C-75	2-15/16	343	4845	4440
TL118B-85	85	380	TL118C-76	3	343	5108	4687
TL118B-90	90	400	TL118C-79	3-1/8	360	5370	4920
TL118B-95	95	400	TL118C-83	3-1/4	360	6357	5480
TL118B-100	100	430	TL118C-86	3-3/8	380	7285	6280
TL118B-105	105	430	TL118C-89	3-1/2	380	7946	6850
TL118B-110	110	465	TL118C-92	3-5/8	400	8387	7230
TL118B-115	115	465	TL118C-95	3-3/4	400	9072	7820
TL118B-120	120	465	TL118C-98	3-7/8	400	9628	8300
TL118B-125	125	500	TL118C-102	4	430	10336	8910
TL118B-130	130	500	TL118C-105	4-1/8	430	11020	9500
TL118B-135	135	520	TL118C-110	4-5/16	430	11832	10200
TL118B-145	145	550	TL118C-116	4-9/16	465	12389	10680
TL118B-150	150	550	TL118C-119	4-11/16	465	12876	11100
TL118B-155	155	565	TL118C-125	4-15/16	500	13503	11640
			TL118C-137	5-3/8	520	13932	12010
			TL118C-152	6	550	14535	12530

TL119防爆弯柄敲击呆扳手

Wrench, Bent Striking Open



规格及主要技术参数

产品代号 Number	规格(S) mm	长度(L) mm	铍青铜(Be-Cu) g	铝青铜(Al-Cu) g
TL119-24	24	150	245	220
TL119-27	27	175	420	380
TL119-30	30	190	480	440
TL119-32	32	190	480	440
TL119-34	34	200	680	620
TL119-36	36	210	680	620
TL119-38	38	230	980	800
TL119-41	41	230	950	860
TL119-46	46	250	1270	1150
TL119-50	50	275	1380	1250
TL119-55	55	305	1780	1620
TL119-60	60	315	2560	2350
TL119-65	65	335	3000	2750
TL119-70	70	350	3542	3250
TL119-75	75	350	4023	3690
TL119-80	80	370	4578	4200

TL120防爆弯柄敲击梅花扳手

Wrench, Striking Box Bent



规格及主要技术参数

产品代号 Number	规格(S) mm	长度(L) mm	铍青铜(Be-Cu) g	铝青铜(Al-Cu) g
TL120-24	24	160	280	240
TL120-27	27	175	370	335
TL120-30	30	190	525	475
TL120-32	32	190	500	450
TL120-34	34	210	630	570
TL120-36	36	210	630	570
TL120-38	38	225	750	650
TL120-41	41	225	750	650
TL120-46	46	240	1160	1030
TL120-50	50	255	1240	1100
TL120-55	55	270	1450	1285
TL120-60	60	285	1820	1640
TL120-65	65	300	2645	2390
TL120-70	70	320	2960	2675
TL120-75	75	350	3460	3175
TL120-80	80	370	3924	3600

TL121防爆凸型敲击梅花扳手

Wrench, Striking Convex Box



规格及主要技术参数

产品代号 Number	规格(S) mm	长度(L) mm	铍青铜(Be-Cu) g	铝青铜(Al-Cu) g
TL121-24	24	165	330	300
TL121-27	27	175	370	335
TL121-30	30	185	530	480
TL121-32	32	185	475	430
TL121-34	34	210	740	670
TL121-36	36	210	740	670
TL121-38	38	210	950	860
TL121-41	41	227	950	860
TL121-46	46	245	1270	1145
TL121-50	50	257	1590	1435
TL121-55	55	267	1800	1625
TL121-60	60	278	2115	1910
TL121-65	65	298	2580	2340
TL121-70	70	320	2960	2680
TL121-75	75	326	3350	3000
TL121-80	80	350	3794	3480
TL121-85	85	370	4360	4000

TL123防爆活扳手

Wrench, Adjustable



规格及主要技术参数

产品代号 Number	规格(S) mm	长度(L) mm	铍青铜(Be-Cu) g	铝青铜(Al-Cu) g
TL123-100	100*13	100	33	30
TL123-150	150*18	150	135	120
TL123-200	200*24	200	281	255
TL123-250	250*30	250	440	401
TL123-300	300*36	300	720	655
TL123-375	375*45	375	1410	1290
TL123-450	450*55	450	2261	2065
TL123-600	600*65	600	4705	4301

TL122防爆高颈敲击梅花扳手

Wrench, Offset Striking Box

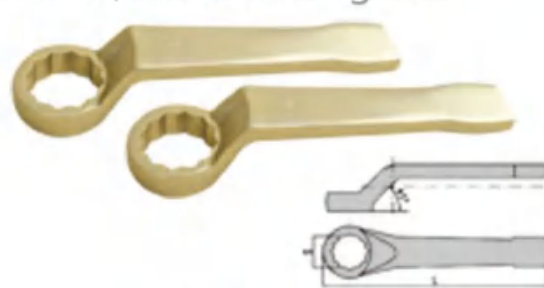

规格及主要技术参数

产品代号 Number	规格(S) mm	长度(L) mm	铍青铜(Be-Cu) g	铝青铜(Al-Cu) g
TL122-24	24	160	370	335
TL122-27	27	180	475	430
TL122-30	30	200	615	555
TL122-32	32	200	615	555
TL122-34	34	220	825	745
TL122-36	36	220	825	745
TL122-38	38	240	950	860
TL122-41	41	240	950	860
TL122-46	46	250	1330	1200
TL122-50	50	270	1650	1450
TL122-55	55	295	2000	1800
TL122-60	60	317	2430	2200
TL122-65	65	330	2750	2490
TL122-70	70	350	3385	3060
TL122-75	75	370	4655	4205
TL122-80	80	385	5020	4540
TL122-85	85	395	5505	5050

TL124防爆猴式活扳手

Wrench, Monkey

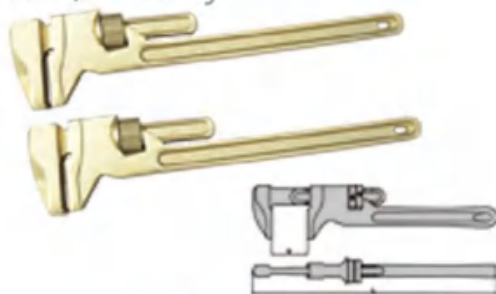

规格及主要技术参数

产品代号 Number	规格(S) mm	长度(L) mm	铍青铜(Be-Cu) g	铝青铜(Al-Cu) g
TL124-240	240*45	240	510	470
TL124-254	254*48	254	615	560
TL124-305	305*58	305	910	820
TL124-350	350*65	350	1220	1120
TL124-380	380*70	380	1465	1340
TL124-500	500*80	500	2650	2200
TL124-580	580*105	580	4240	3700



TL125防爆加力杆梅花扳手

Ring Wrench for extension

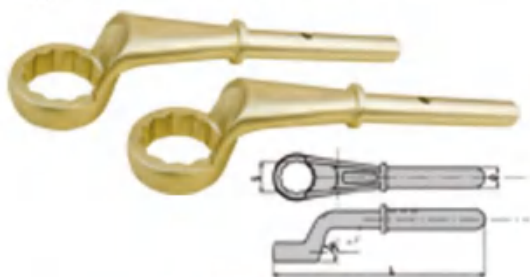

规格及主要技术参数

产品代号 Number	规格(S) mm	长度(L) mm	产品代号 Number	规格(S) mm	长度(L) mm	铍青铜 (Be-Cu)g	铝青铜 (Al-Cu)g
TL125-30	30	200	TL125A-30	1-3/16	300	580	525
TL125-32	32	235	TL125A-32	1-1/4	235	795	715
TL125-34	34	245	TL125A-35	1-3/8	245	900	815
TL125-36	36	245	TL125A-38	1-1/2	245	900	815
TL125-37	37	245	TL125A-39	1-9/16	265	900	815
TL125-38	38	245	TL125A-41	1-5/8	265	1060	955
TL125-41	41	265	TL125A-43	1-11/16	265	1060	955
TL125-42	42	265	TL125A-44	1-3/4	280	1330	1147
TL125-46	46	280	TL125A-46	1-13/16	280	1480	1340
TL125-50	50	290	TL125A-51	2	290	1690	1530
TL125-55	55	300	TL125A-56	2-3/16	300	1850	1670
TL125-60	60	345	TL125A-60	2-3/8	345	2960	2670
TL125-65	65	355	TL125A-64	2-1/2	355	3380	3055
TL125-67	67	355	TL125A-65	2-9/16	355	3910	3530
TL125-70	70	365	TL125A-67	2-5/8	355	3910	3530
TL125-71	71	365	TL125A-70	2-3/4	365	3910	3530
TL125-75	75	375	TL125A-75	2-15/16	375	4335	3920
TL125-77	77	375	TL125A-79	3-1/8	385	5180	4680
TL125-80	80	385	TL125A-83	3-1/4	385	5180	4680

TL126防爆梅花扳手加力杆

Extension for



规格及主要技术参数

产品代号 Number	规格(φ) mm	长度(L) mm	铍青铜(Be-Cu) g	铝青铜(Al-Cu) g
TL126-2430	19	460	880	830
TL126-3241	22	610	1280	1210
TL126-4650	25	760	2125	2005
TL126-6080	30	860	3265	3080

TL126A 防爆美式敲击梅花扳手

Offset Slogging Box Wrench(American Type)



规格及主要技术参数

产品代号 Number	规格(S) mm	长度(L) mm	铍青铜(Be-Cu) g	铝青铜(Al-Cu) g
TL126A-24	24	240	950	860
TL126A-27	27	270	1150	1035
TL126A-30	30	280	1480	1340
TL126A-32	32	900	1690	1530
TL126A-36	36	300	1900	1720
TL126A-41	41	320	2110	1910
TL126A-46	46	340	2750	2485
TL126A-50	50	350	3170	2870
TL126A-55	55	360	4125	3730
TL126A-60	60	375	4335	3920
TL126A-65	65	390	4440	4010
TL126A-70	70	400	5400	4872
TL126A-75	75	420	5810	5255
TL126A-80	80	440	7295	6600
TL126A-90	90	480	9740	8800
TL126A-100	100	515	11300	10200
TL126A-110	110	550	13400	12100
TL126A-120	120	585	15500	14000
TL126A-130	130	620	17700	16000



TL127 防爆撬棒呆扳手



Wrench, Construction with Pin

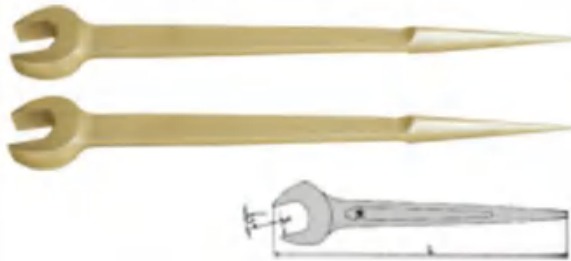

规格及主要技术参数

产品代号 Number	规格(S) mm	长度(L) mm	产品代号 Number	规格(S) mm	长度(L) mm	铍青铜 (Be-Cu)g	铝青铜 (Al-Cu)g
TL127-17	17	220	TL127A-18	11/16	220	125	115
TL127-18	18	220	TL127A-19	3/4	240	160	145
TL127-19	19	240	TL127A-20	25/32	240	160	145
TL127-20	20	240	TL127A-21	13/16	240	210	190
TL127-21	21	260	TL127A-22	7/8	260	210	190
TL127-22	22	260	TL127A-24	15/16	280	210	190
TL127-23	23	280	TL127A-25	31/32	280	265	240
TL127-24	24	280	TL127A-26	1	280	265	240
TL127-25	25	280	TL127A-27	1-1/16	300	350	315
TL127-26	26	300	TL127A-29	1-1/8	310	350	315
TL127-27	27	300	TL127A-30	1-3/16	310	350	315
TL127-28	28	310	TL127A-32	1-1/4	340	445	405
TL127-29	29	320	TL127A-33	1-5/16	360	445	405
TL127-30	30	320	TL127A-35	1-3/8	360	445	405
TL127-32	32	340	TL127A-37	1-7/16	360	530	480
TL127-33	33	340	TL127A-38	1-1/2	380	600	550
TL127-34	34	360	TL127A-39	1-9/16	380	600	550
TL127-35	35	360	TL127A-41	1-5/8	380	720	650
TL127-36	36	360	TL127A-43	1-11/16	380	720	650
TL127-37	37	360	TL127A-44	1-3/4	400	865	794
TL127-38	38	380	TL127A-46	1-13/16	400	1010	910
TL127-41	41	380	TL127A-48	1-7/8	400	1010	910
TL127-42	42	380	TL127A-51	2	420	1063	976
TL127-46	46	400				1115	1010
TL127-47	47	400				1140	1046
TL127-50	50	420				1165	1055
TL127-55	55	450				1485	1345
TL127-60	60	480				2015	1825
TL127-65	65	500				2670	2450

TL127B 防爆高颈撬棒呆扳手



Wrench, Construction with Pin Offset

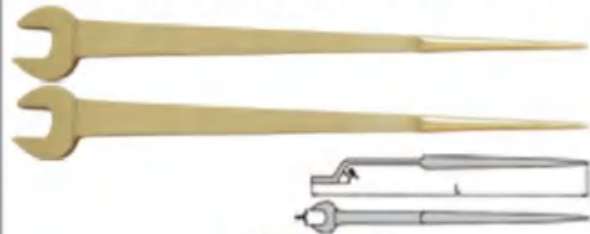

规格及主要技术参数

产品代号 Number	规格(S) mm	长度(L) mm	铍青铜(Be-Cu) g	铝青铜(Al-Cu) g
TL127B-17	17	320	210	195
TL127B-19	19	350	320	290
TL127B-22	22	350	430	390
TL127B-24	24	370	480	430
TL127B-27	25	370	640	580
TL127B-30	30	400	800	720
TL127B-32	32	400	800	720
TL127B-36	36	430	950	860
TL127B-41	41	470	1270	1150
TL127B-46	46	500	1600	1445
TL127B-50	50	530	1885	1700
TL127B-55	55	560	2160	1950

TL128 防爆撬棒梅花扳手



Wrench, Construction



规格及主要技术参数

产品代号 Number	规格(S) mm	长度(L) mm	产品代号 Number	规格(S) mm	长度(L) mm	铍青铜 (Be-Cu)g	铝青铜 (Al-Cu)g
TL128-17	17	220	TL128A-18	11/16	220	165	145
TL128-19	19	240	TL128A-19	3/4	240	230	195
TL128-22	22	270	TL128A-21	13/16	250	303	274
TL128-24	24	290	TL128A-22	7/8	270	361	330
TL128-27	27	320	TL128A-24	15/16	290	472	430
TL128-30	30	350	TL128A-29	1-1/16	320	650	585
TL128-32	32	370	TL128A-30	1-3/16	350	680	620
TL128-34	34	380	TL128A-32	1-1/4	370	803	730
TL128-36	36	390	TL128A-33	1-5/16	380	950	850
TL128-38	38	400	TL128A-35	1-3/8	390	1005	880
TL128-41	41	410	TL128A-38	1-1/2	400	1430	1025
TL128-46	46	420	TL128A-39	1-9/16	410	1460	1310
TL128-50	50	430	TL128A-41	1-5/8	410	1580	1420
TL128-55	55	440	TL128A-44	1-3/4	420	1870	1690
TL128-60	60	460	TL128A-46	1-13/16	420	2330	2095
TL128-65	65	480	TL128A-51	2	430	2802	2535



TL128B 防爆弯柄撬棒梅花扳手

Wrench, Construction Bent



规格及主要技术参数

产品代号 Number	规格(S) mm	长度(L) mm	产品代号 Number	规格(S) mm	长度(L) mm	铍青铜 (Be-Cu)g	铝青铜 (Al-Cu)g
TL128B-17	17	230	TL128C-18	11/16	220	182	167
TL128B-18	18	230	TL128C-19	3/4	240	198	182
TL128B-19	19	240	TL128C-20	25/32	240	253	233
TL128B-20	20	250	TL128C-21	13/16	250	267	245
TL128B-21	21	260	TL128C-22	7/8	270	276	254
TL128B-22	22	270	TL128C-24	15/16	290	334	307
TL128B-23	23	280	TL128C-25	31/32	290	363	334
TL128B-24	24	290	TL128C-26	1	300	398	366
TL128B-25	25	300	TL128C-27	1-1/16	320	398	366
TL128B-26	26	310	TL128C-29	1-1/8	330	520	478
TL128B-27	27	320	TL128C-30	1-3/16	350	520	478
TL128B-28	28	330	TL128C-32	1-1/4	370	715	656
TL128B-29	29	340	TL128C-33	1-5/16	380	715	656
TL128B-30	30	350	TL128C-35	1-3/8	390	715	656
TL128B-32	32	370	TL128C-37	1-7/16	390	748	687
TL128B-33	33	380	TL128C-38	1-1/2	400	884	812
TL128B-34	34	380	TL128C-39	1-9/16	410	884	812
TL128B-35	35	390	TL128C-41	1-5/8	410	1045	959
TL128B-36	36	390	TL128C-43	1-11/16	420	1045	959
TL128B-37	37	400	TL128C-44	1-3/4	420	1106	1015
TL128B-38	38	400	TL128C-46	1-13/16	420	1106	1015
TL128B-41	41	410	TL128C-48	1-7/8	420	1573	1444
TL128B-42	42	410	TL128C-51	2	430	1573	1444
TL128B-46	46	420				1606	1474
TL128B-47	47	420				1738	1595
TL128B-50	50	430				1738	1595
TL128B-55	55	440				2057	1887
TL128B-60	60	460				2563	2352
TL128B-65	65	480				3149	2889

TL129 防爆欧式棘轮扳手

Ratchet Wrench



规格及主要技术参数

产品代号 Number	规格(S) mm	长度(L) mm	铍青铜(Be-Cu) g	铝青铜(Al-Cu) g
TL129-16	16	200	260	230
TL129-17	17	200	260	230
TL129-18	18	200	260	230
TL129-19	19	200	260	230
TL129-21	21	220	340	300
TL129-22	22	220	340	300
TL129-24	24	220	340	300
TL129-27	27	245	560	500
TL129-30	30	280	840	750
TL129-32	32	280	840	750
TL129-34	34	290	1180	1050
TL129-36	36	290	1180	1050
TL129-41	41	295	1230	1100
TL129-46	46	360	2060	1850
TL129-50	50	360	2230	2000
TL129-55	55	440	2900	2600
TL129-60	60	460	2900	2600
TL129-65	65	480	3422	2950
TL129-70	70	500	4107	3540
TL129-75	75	520	4582	3950
TL129-80	80	520	5244	4520

TL130 防爆扁尾棘轮扳手

Ratchet Wrench



规格及主要技术参数

产品代号 Number	规格(S) mm	长度(L) mm	铍青铜(Be-Cu) g	铝青铜(Al-Cu) g
TL130-16	16	200	725	621
TL130-17	17	200	725	621
TL130-18	18	200	745	652
TL130-19	19	200	745	652
TL130-21	21	220	942	831
TL130-22	22	220	963	835
TL130-24	24	220	1175	1022
TL130-27	27	245	1253	1102
TL130-30	30	280	1532	1325
TL130-32	32	280	1622	1427
TL130-34	34	290	1821	1633
TL130-36	36	290	1829	1673
TL130-41	41	295	2129	1948
TL130-46	46	360	2784	2400
TL130-50	50	360	3399	2930
TL130-55	55	440	3933	3390



TL131 防爆内六角扳手

Wrench, Hex Key

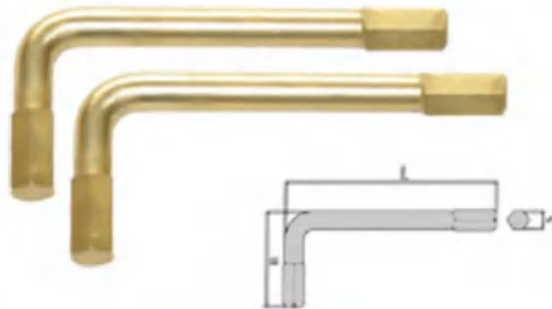

规格及主要技术参数

产品代号 Number	规格(S) mm	长度(L) mm	产品代号 Number	规格(S) mm	长度(L) mm	铍青铜 (Be-Cu)g	铝青铜 (Al-Cu)g
TL131-015	1.5	50	TL131A-016	1/16	50	6	5
TL131-02	2	50	TL131A-03	1/8	63	6	5
TL131-025	2.5	50	TL131A-04	5/32	70	6	5
TL131-03	3	63	TL131A-05	3/16	70	8	7
TL131-04	4	70	TL131A-06	1/4	90	10	8
TL131-05	5	80	TL131A-08	5/16	100	16	12
TL131-06	6	90	TL131A-09	3/8	106	25	20
TL131-07	7	95	TL131A-11	7/16	118	34	30
TL131-08	8	100	TL131A-13	1/2	125	50	45
TL131-09	9	106	TL131A-14	9/16	150	61	55
TL131-10	10	112	TL131A-16	5/8	165	82	70
TL131-11	11	118	TL131A-17	11/16	168	100	90
TL131-12	12	125	TL131A-19	3/4	177	145	130
TL131-14	14	150	TL131A-21	13/16	184	211	191
TL131-17	17	168	TL131A-22	7/8	186	370	335
TL131-19	19	177	TL131A-26	1	195	490	445
TL131-20	20	180	TL131A-27	1-1/16	213	610	550
TL131-21	21	184	TL131A-28	1-1/8	220	652	595
TL131-22	22	186	TL131A-30	1-3/16	240	675	615
TL131-24	24	192	TL131A-32	1-1/4	266	825	755
TL131-27	27	216	TL131A-33	1-5/16	275	1220	1115
TL131-30	30	240	TL131A-35	1-3/8	280	1615	1475
TL131-32	32	266	TL131A-37	1-7/16	294	2065	1885
TL131-36	36	294	TL131A-38	1-1/2	310	2905	2650
TL131-41	41	320	TL131A-39	1-9/16	320	4120	3760
TL131-46	46	343	TL131A-41	1-5/8	320	5220	4850

TL131B 防爆加长内六角扳手

Wrench, Hex Key Lengthen

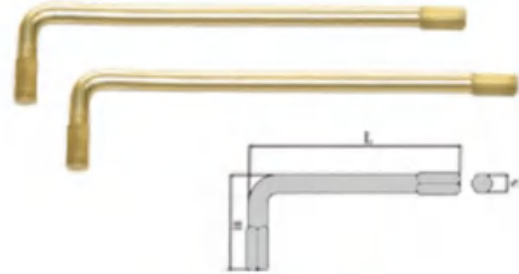

规格及主要技术参数

产品代号 Number	规格(S) mm	长度(L) mm	铍青铜(Be-Cu) g	铝青铜(Al-Cu) g
TL131B-3	3	25	7	6
TL131B-4	4	30	14	12
TL131B-5	5	32	21	18
TL131B-6	6	37	35	30
TL131B-8	8	44	82	70
TL131B-10	10	45	140	120
TL131B-12	12	52	221	190
TL131B-14	14	58	348	300
TL131B-17	17	65	441	380
TL131B-19	19	72	569	490

TL132 防爆球头内六角扳手

Wrench, Hex Key with Ball

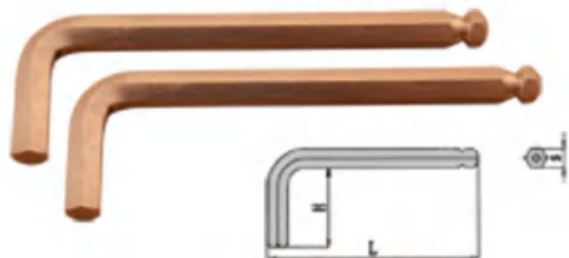

规格及主要技术参数

产品代号 Number	规格(S) mm	长度(L) mm	铍青铜(Be-Cu) g
TL132-02	2	50	3
TL132-025	2.5	55	3
TL132-03	3	63	5
TL132-04	4	70	12
TL132-05	5	80	22
TL132-06	6	90	30
TL132-07	7	95	50
TL132-08	8	100	56
TL132-09	9	106	85
TL132-10	10	112	100
TL132-12	12	125	175



TL132A 防爆加长球头内六角

Wrench, Hex Key with Ball Lengthen

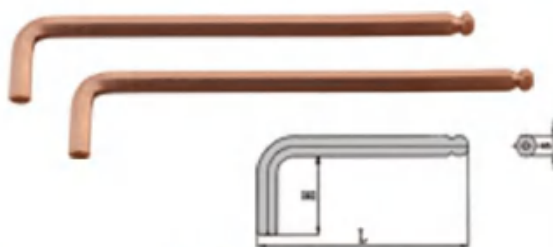

规格及主要技术参数

产品代号 Number	规格(S) mm	长度(L) mm	铍青铜(Be-Cu) g
TL132A-3	3	20	10
TL132A-4	4	25	21
TL132A-5	5	28	36
TL132A-6	6	32	60
TL132A-7	7	34	87
TL132A-8	8	36	118
TL132A-10	10	40	205
TL132A-12	12	45	339
TL132A-14	14	48	430

TL133-135 防爆大装内六角扳手

Wrench, Hex Key Set



规格及主要技术参数

产品代号 Number	规格(S) mm	长度		铍青铜(Be-Cu) g	铝青铜(Al-Cu) g
		(L1)mm	(L2)mm		
TL133	2,2.5,3,4,5,6,8,10	180	155		
TL134	4,5,6,8,10,12,14,17	820	699		
TL135	2,2.5,3,4,5,6,8,12,14,17	840	720		

TL136 防爆T型内六角

Wrench, T-type Sliding Hex



规格及主要技术参数

产品代号 Number	规格(S) mm	长度(L) mm	铍青铜(Be-Cu) g	铝青铜(Al-Cu) g
TL136-10	10	150	270	245
TL136-12	12	170	290	265
TL136-14	14	170	400	365
TL136-17	17	190	465	423
TL136-19	19	220	615	563
TL136-22	22	240	660	605
TL136-24	24	260	935	855
TL136-27	27	260	1000	915
TL136-30	30	280	1306	1195
TL136-32	32	280	1505	1375
TL136-36	36	300	1802	1645
TL136-41	41	300	2075	1895

TL136A 防爆T型塑柄内六角

Wrench, T-type Sliding Hex



规格及主要技术参数

产品代号 Number	规格(S) mm	长度		铍青铜(Be-Cu) g	铝青铜(Al-Cu) g
		(L1)mm	(L2)mm		
TL136A-3	3	143	100	36	31
TL136A-4	4	143	100	45	38
TL136A-5	5	155	100	71	61
TL136A-6	6	155	100	83	71
TL136A-8	8	155	100	113	97
TL136A-10	10	155	100	183	157
TL136A-12	12	155	100	230	198
TL136A-14	14	155	100	286	246



TL136B 防爆T型塑柄加长内六角
Wrench, T-type Sliding Hex



规格及主要技术参数

产品代号 Number	规格(S) mm	长度		铍青铜(Be-Cu) g	铝青铜(Al-Cu) g
		(L1)mm	(L2)mm		
TL136B-3	3	195	150	34	34
TL136B-4	4	195	150	43	43
TL136B-5	5	205	150	69	69
TL136B-6	6	205	150	83	83
TL136B-8	8	205	150	118	118
TL136B-10	10	205	150	191	191
TL136B-12	12	205	150	247	247
TL136B-14	14	205	150	312	312

TL136C 防爆T型塑柄球头内六角
Wrench, T-type Sliding Hex Ball



规格及主要技术参数

产品代号 Number	规格(S) mm	长度		铍青铜(Be-Cu) g
		(L1)mm	(L2)mm	
TL136C-3	3	145	100	36
TL136C-4	4	145	100	45
TL136C-5	5	205	150	81
TL136C-6	6	205	150	97
TL136C-8	8	205	150	137
TL136C-10	10	255	200	261
TL136C-12	12	255	200	343
TL136C-14	14	255	200	441

TL136D 防爆六角螺丝刀
Hex key Screwdriver



规格及主要技术参数

产品代号 Number	规格(S) mm	长度		铍青铜(Be-Cu) g	铝青铜(Al-Cu) g
		(L1)mm	(L2)mm		
TL136D-3	3	153	75	29	25
TL136D-4	4	153	75	47	40
TL136D-5	5	180	80	58	50
TL136D-6	6	180	80	87	75
TL136D-8	8	240	120	163	140
TL136D-10	10	240	120	256	220
TL136D-12	12	240	120	337	290

TL136E 防爆六角螺丝刀
Hex key Screwdriver



规格及主要技术参数

产品代号 Number	规格(S) mm	长度		铍青铜(Be-Cu) g	铝青铜(Al-Cu) g
		(L1)mm	(L2)mm		
TL136E-3	3	190	100	41	35
TL136E-4	4	190	100	58	50
TL136E-5	5	200	100	70	60
TL136E-6	6	225	125	105	90
TL136E-8	8	260	150	163	140
TL136E-10	10	260	150	244	210
TL136E-12	12	260	150	325	280



TL136F 防爆球头六角螺丝刀

Hex key Screwdriver Ball



规格及主要技术参数

产品代号 Number	规格(S) mm	长度		铍青铜(Be-Cu) g
		(L1)mm	(L2)mm	
TL136F-3	3	190	100	41
TL136F-4	4	190	100	58
TL136F-5	5	200	100	70
TL136F-6	6	225	125	105
TL136F-8	8	260	150	163
TL136F-10	10	260	150	244
TL136F-12	12	280	150	325

TL137 防爆内四角扳手

Wrench, Square Key

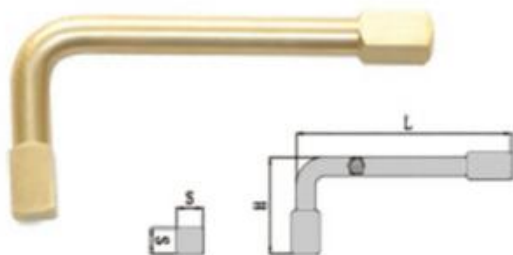

规格及主要技术参数

产品代号 Number	规格(S) mm	长度(L) mm	高度(H) mm	铍青铜(Be-Cu) g	铝青铜(Al-Cu) g
TL137-8	8	92	44	55	50
TL137-9	9	97	44	65	60
TL137-10	10	110	45	90	80
TL137-11	11	119	48	110	100
TL137-12	12	130	52	155	140
TL137-13	13	140	54	185	170
TL137-14	14	150	58	220	200
TL137-15	15	156	60	280	250
TL137-16	16	162	63	320	290
TL137-17	17	168	65	395	355
TL137-18	18	173	69	465	420
TL137-19	19	173	72	520	470

TL138 防爆单头C型扳手

Wrench C



规格及主要技术参数

产品代号 Number	规格(S) mm	长度(L) mm	铍青铜(Be-Cu) g	铝青铜(Al-Cu) g
TL138-40	40*450	450	1205	1102

TL139 防爆双头C型扳手

Wrench, Double C



规格及主要技术参数

产品代号 Number	规格(S) mm	长度(L) mm	铍青铜(Be-Cu) g	铝青铜(Al-Cu) g
TL139-1418	14.5*18.5	200	370	335
TL139-1725	17.5*25.5	250	635	575
TL139-2534	25.5*34	450	2385	2160



TL140 防爆油管扳手

Flare Nut Open Ring Wreches



规格及主要技术参数

产品代号 Number	规格(S) mm	长度(L) mm	铍青铜(Be-Cu) g	铝青铜(Al-Cu) g
TL140-0607	6*7	95	17	15
TL140-0810	8*10	115	32	29
TL140-0911	9*11	125	37	34
TL140-1012	10*12	140	55	48
TL140-1214	12*14	145	70	62
TL140-1417	14*17	165	100	90
TL140-1618	16*18	170	127	115
TL140-1719	17*19	185	132	120
TL140-1922	19*22	200	180	165
TL140-2224	22*24	220	240	215
TL140-2427	24*27	255	320	288
TL140-2730	27*30	280	430	389
TL140-3032	30*32	295	498	450
TL140-3034	30*34	310	588	535
TL140-3436	34*36	345	758	685
TL140-3641	36*41	365	935	845

TL141 防爆桶盖扳手单头

Wrench, Bung

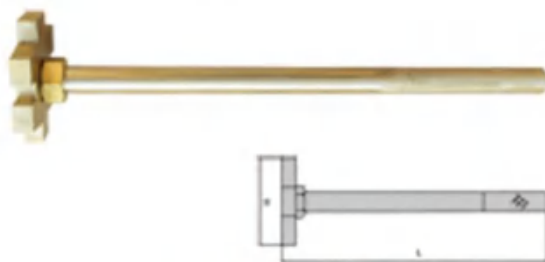

规格及主要技术参数

产品代号 Number	规格(S) mm	长度(L) mm	铍青铜(Be-Cu) g	铝青铜(Al-Cu) g
TL141-300	300	300	630	580

TL142 防爆桶盖扳手双头

Wrench, Bung

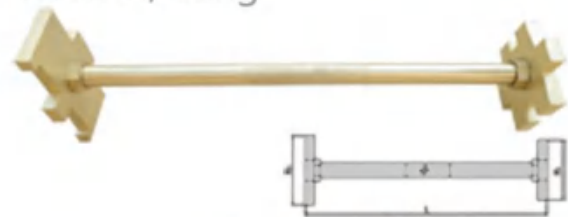

规格及主要技术参数

产品代号 Number	规格(S) mm	长度(L) mm	铍青铜(Be-Cu) g	铝青铜(Al-Cu) g
TL142-350	350	350	1165	1070

TL143 防爆万能开桶扳手

Wrench, Bung

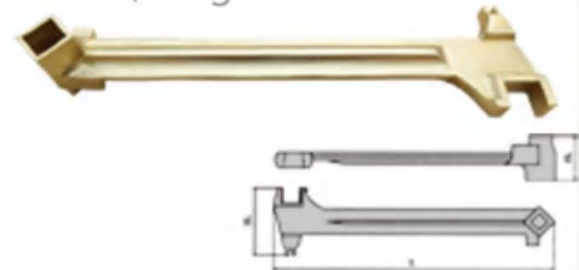

规格及主要技术参数

产品代号 Number	规格(S) mm	长度(L) mm	铍青铜(Be-Cu) g	铝青铜(Al-Cu) g
TL143-385	385	385	1250	1150

TL143A 防爆多用开桶扳手

Wrench, Bung



规格及主要技术参数

产品代号 Number	规格(S) mm	长度(L) mm	铍青铜(Be-Cu) g	铝青铜(Al-Cu) g
TL143A-300	38 52	300	830	750



TL144 防爆氧气瓶扳手

Oxygen Bottle Wrench



规格及主要技术参数

产品代号 Number	规格(S) mm	长度(L) mm	铍青铜(Be-Cu) g	铝青铜(Al-Cu) g
TL144-10	3/8	154	185	170

TL144A 防爆氧气瓶扳手

Oxygen Bottle Wrench



规格及主要技术参数

产品代号 Number	规格(S) mm	长度(L) mm	铍青铜(Be-Cu) g	铝青铜(Al-Cu) g
TL144A-10	3/8	140	185	170

TL145 防爆乙炔扳手

Ethyne Bottle Wrench



规格及主要技术参数

产品代号 Number	规格(S) mm	长度(L) mm	铍青铜(Be-Cu) g	铝青铜(Al-Cu) g
TL145-10	100*10	100	220	190

TL146 防爆方头F扳手

Valve Handle

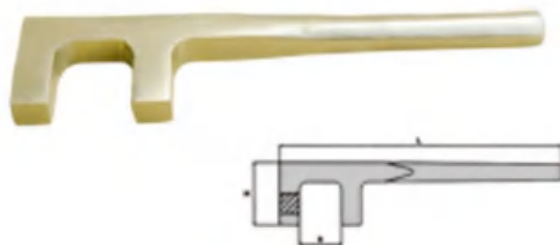

规格及主要技术参数

产品代号 Number	规格(S) mm	长度(L) mm	铍青铜(Be-Cu) g	铝青铜(Al-Cu) g
TL146-30	30*200	200	405	340
TL146-35	35*250	250	465	410
TL146-40	40*300	300	595	540
TL146-45	45*350	350	835	762
TL146-50	50*400	400	892	815
TL146-55	55*450	450	1270	1110
TL146-60	60*500	500	1570	1435
TL146-70	70*600	600	1945	1775
TL146-80	80*700	700	2405	2190
TL146-90	90*800	800	3360	3060
TL146-100	100*900	900	3870	3515
TL146-110	110*1000	1000	4170	3795

TL147 防爆圆头F扳手

Valve Handle

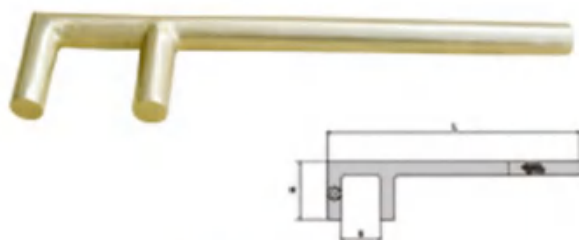

规格及主要技术参数

产品代号 Number	规格(S) mm	长度(L) mm	铍青铜(Be-Cu) g	铝青铜(Al-Cu) g
TL147-30	30*200	200	280	250
TL147-35	35*250	250	364	325
TL147-40	40*300	300	470	422
TL147-45	45*350	350	610	540
TL147-50	50*400	400	705	615
TL147-55	55*450	450	960	870
TL147-60	60*500	500	1205	1105
TL147-70	70*600	600	1540	1360
TL147-80	80*700	700	1910	1650
TL147-90	90*800	800	2380	2130
TL147-100	100*900	900	2980	2700
TL147-110	110*1000	1000	3330	3010



TL147A 防爆双头圆头F扳手

Double Valve Handle



规格及主要技术参数

产品代号 Number	规格(S) mm	长度(L) mm	铍青铜(Be-Cu) g	铝青铜(Al-Cu) g
TL147A	30-40	500	836	720

TL148 防爆防滑F扳手

Valve Wheel Hook Deslick

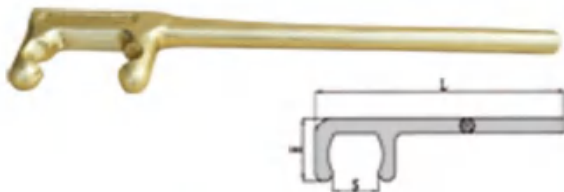

规格及主要技术参数

产品代号 Number	规格(S) mm	长度(L) mm	铍青铜(Be-Cu) g	铝青铜(Al-Cu) g
TL148-35	35*250	250	375	340
TL148-45	45*320	320	585	530
TL148-50	50*400	400	740	670
TL148-55	55*450	450	830	750
TL148-60	60*500	500	1200	1100
TL148-70	70*600	600	1380	1250
TL148-90	90*800	800	2310	2100

TL148B 防爆A型F扳手

Valve Wheel Hook Deslick

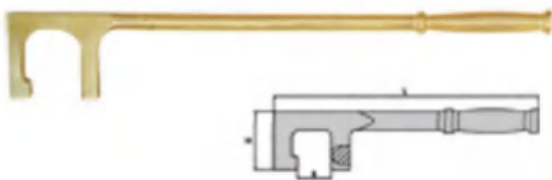

规格及主要技术参数

产品代号 Number	规格(S) mm	长度(L) mm	铍青铜(Be-Cu) g	铝青铜(Al-Cu) g
TL148B-35	35*250	250	550	475
TL148B-45	45*320	320	905	780
TL148B-50	50*400	400	1050	910
TL148B-55	55*450	450	1260	1130
TL148B-60	60*500	500	1405	1250
TL148B-70	70*600	600	2220	2005
TL148B-90	90*800	800	3360	3060

TL149 防爆扭力扳手

Torque Wrench



规格及主要技术参数

产品代号 Number	规格(S) mm	长度(L) mm	铍青铜(Be-Cu) g	铝青铜(Al-Cu) g
TL149-13	1/2 0-300nm	490	1340	1210
TL149-19	3/4 0-500nm	560	2050	1930

TL150 防爆勾扳手

Wrench Hook



规格及主要技术参数

产品代号 Number	规格(D) mm	长度(L) mm	铍青铜(Be-Cu) g	铝青铜(Al-Cu) g
TL150-2832	28-32	140	63	50
TL150-3436	34-36	170	95	85
TL150-3842	38-42	176	105	95
TL150-4552	45-52	209	160	145
TL150-5562	55-62	244	225	200
TL150-6875	68-75	250	265	240
TL150-8090	80-90	284	375	335
TL150-9510	95-100	288	415	370
TL150-1115	110-115	337	770	690
TL150-1213	120-130	343	770	690
TL150-1314	135-145	388	1110	1000
TL150-2224	220-240	410	1560	1280



TL151 防爆可调勾扳手

Wrench Adjustable Hook



规格及主要技术参数

产品代号 Number	规格(D) mm	长度(L) mm	铍青铜(Be-Cu) g	铝青铜(Al-Cu) g
TL151-1420	14-20	140	120	110
TL151-3275	32-75	212	260	235
TL151-5012	50-120	285	515	460
TL151-1117	115-170	310	670	600

TL152B 防爆双头勾扳手

Coupling Spanner



规格及主要技术参数

产品代号 Number	规格(S) mm	长度(L) mm	铍青铜(Be-Cu) g	铝青铜(Al-Cu) g
TL152B	14	440	928	800

TL152 防爆万能勾扳手

Universal Wrench



规格及主要技术参数

产品代号 Number	规格(D) mm	长度(L) mm	铍青铜(Be-Cu) g	铝青铜(Al-Cu) g
TL152-200	25	200	360	330
TL152-250	30	250	905	780
TL152-300	40	300	1405	1250

TL153 防爆阀门扳手

Valve Square Driver

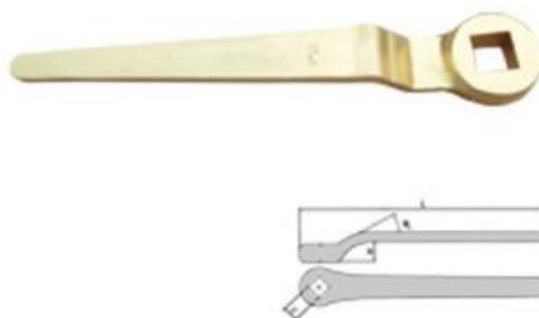

规格及主要技术参数

产品代号 Number	规格(S) mm	长度(L) mm	铍青铜(Be-Cu) g	铝青铜(Al-Cu) g
TL153-6	6*110	110	65	55
TL153-8	8*120	120	75	61
TL153-9	9*130	130	90	75
TL153-10	10*140	140	105	85
TL153-11	11*150	150	130	102
TL153-12	12*170	170	180	145
TL153-14	14*220	220	300	261
TL153-17	17*270	270	420	366
TL153-19	19*350	350	740	662
TL153-22	22*400	400	1000	896
TL153-24	24*450	450	1120	900
TL153-27	27*540	540	1650	1200

TL152A 防爆双齿勾扳手

Wrench Hook



规格及主要技术参数

产品代号 Number	规格(D) mm	长度(L) mm	铍青铜(Be-Cu) g	铝青铜(Al-Cu) g
TL152A	118	280	350	310



TL153A 防爆长方孔阀门扳手 >

Valve Square Driver

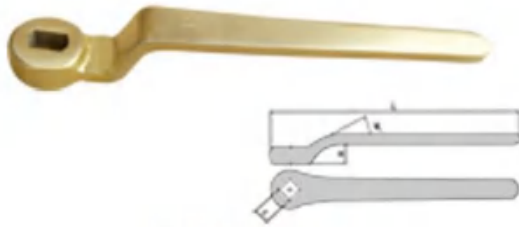

规格及主要技术参数

产品代号 Number	规格(S) mm	长度(L) mm	铍青铜(Be-Cu) g	铝青铜(Al-Cu) g
TL153A-1015	10*15	160	180	145
TL153A-1220	12*20	180	240	215
TL153A-1318	13*18	180	240	215
TL153A-1420	14*20	220	300	261
TL153A-1520	15*20	220	300	261
TL153A-1619	16*19	250	420	360
TL153A-1623	16*23	250	420	360
TL153A-1625	16*25	250	420	360
TL153A-1725	17*25	280	510	440
TL153A-1825	18*25	280	510	440
TL153A-1828	18*28	300	580	490
TL153A-1922	19*22	340	740	662
TL153A-2023	20*23	340	740	662
TL153A-2025	20*25	340	740	662
TL153A-2030	20*30	400	1000	892
TL153A-2232	22*32	450	1200	1060
TL153A-2328	23*28	450	1200	1060
TL153A-2335	23*35	450	1200	1060
TL153A-2437	24*27	500	1650	1200
TL153A-2740	27*40	600	1980	1650

TL154 防爆带抓阀门扳手 >

Valve Spanner

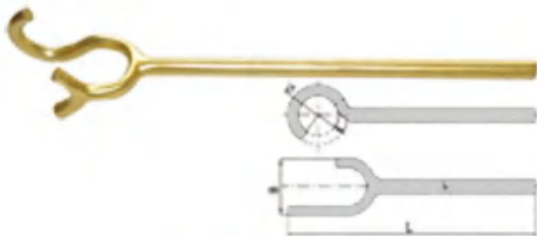

规格及主要技术参数

产品代号 Number	规格(S) mm	长度(L) mm	铍青铜(Be-Cu) g	铝青铜(Al-Cu) g
TL154-60	60*36	370	730	650
TL154-80	80*48	430	1520	1350
TL154-102	102*62	550	2250	2000

TL155 防爆带抓阀门扳手 >

Valve Spanner

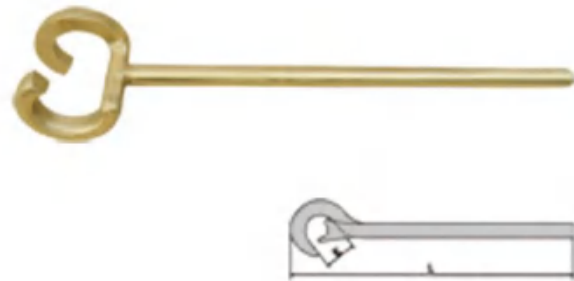

规格及主要技术参数

产品代号 Number	规格(S) mm	长度(L) mm	铍青铜(Be-Cu) g	铝青铜(Al-Cu) g
TL155-30	30*15	250	415	365
TL155-40	40*20	300	640	570
TL155-50	50*25	400	820	745
TL155-60	60*30	550	2250	2000
TL155-130	130*65	750	4300	3850

TL155A 防爆带抓阀门扳手 >

Valve Spanner

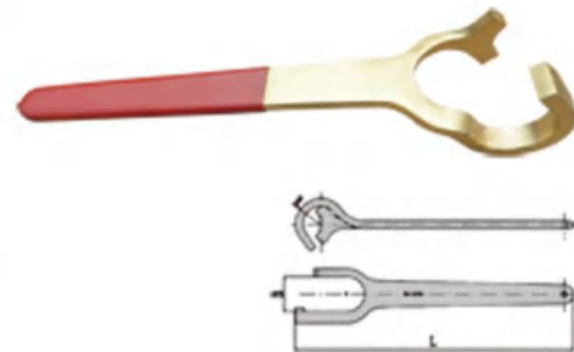

规格及主要技术参数

产品代号 Number	B mm	R mm	L mm	铍青铜(Be-Cu) g	铝青铜(Al-Cu) g
TL155A-30	30	15	250	415	375
TL155A-40	40	20	300	540	485
TL155A-50	50	25	400	1050	950
TL155A-60	60	30	550	1800	1630
TL155A-130	130	65	750	4900	4430



TL155B 防爆k型阀门扳手

Valve Spanner



规格及主要技术参数

产品代号 Number	规格(S) mm	长度(L) mm	铍青铜(Be-Cu) g	铝青铜(Al-Cu) g
TL155B-040	40	300	590	540
TL155B-055	55	450	1165	1050
TL155B-070	70	600	1950	1700
TL155B-090	90	800	2800	2600

TL155C 防爆三爪阀门扳手

Valve Spanner

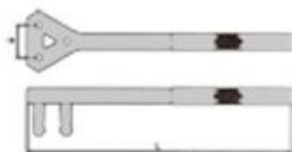

规格及主要技术参数

产品代号 Number	规格(A) mm	长度(L) mm	铍青铜(Be-Cu) g	铝青铜(Al-Cu) g
TL155C-200	25	200	220	200
TL155C-250	35	250	375	340
TL155C-300	42	300	440	400
TL155C-350	62	350	660	600
TL155C-400	90	400	1030	940
TL155C-450	110	450	1430	1300
TL155C-500	165	500	2090	1900
TL155C-550	225	550	2420	2200

TL155D 防爆钻头

Drill Bit



规格及主要技术参数

产品代号 Number	规格(S) mm	长度(L) mm	铍青铜(Be-Cu) g
TL155D-1002	6	100	20
TL155D-1004	7	120	30
TL155D-1006	8	140	50
TL155D-1008	9	160	75
TL155D-1010	10	180	100
TL155D-1012	11	200	120
TL155D-1014	12	220	170
TL155D-1016	13	240	220
TL155D-1018	14	260	280
TL155D-1020	15	280	360
TL155D-1022	16	300	440
TL155D-1024	17	300	500
TL155D-1026	18	320	600
TL155D-1028	19	320	700
TL155D-1030	20	330	800

TL155E 防爆钻头组合

Drill Bit Set-15Pcs



TL155E

6*100mm, 7*120mm, 8*140mm, 9*160mm,
10*180mm, 11*200mm, 12*220mm, 13*240mm,
14*260mm, 15*280mm, 16*300mm, 17*300mm,
18*320mm, 19*320mm, 20*330mm

TIANLONG 天龙防爆工具
高精品质 全国领先品牌



防爆套筒系列

专业制造商

TIANLONG

TIANLONG



TL156 防爆L型套筒扳手



Wrench, Socket L-Type

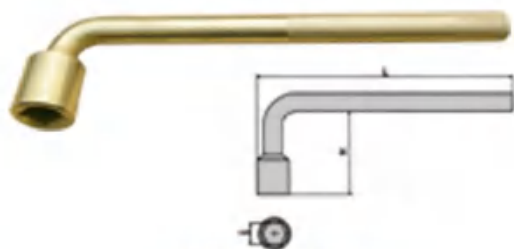

规格及主要技术参数

产品代号 Number	规格(S) mm	长度(L) mm	产品代号 Number	规格(S) mm	长度(L) mm	铍青铜 (Be-Cu)g	铝青铜 (Al-Cu)g
TL156-8	8*33	145	TLA156-8	5/16*33	145	150	60
TL156-9	9*35	155	TLA156-9	3/8*37	168	200	90
TL156-10	10*37	168	TLA156-10	13/32*39	178	200	90
TL156-11	11*39	178	TLA156-11	7/16*42	215	220	135
TL156-12	12*42	215	TLA156-13	1/2*45	240	220	135
TL156-13	13*45	240	TLA156-14	9/16*45	245	250	190
TL156-14	14*45	245	TLA156-15	19/32*48	250	300	215
TL156-15	15*48	250	TLA156-16	5/8*48	255	350	240
TL156-16	16*48	255	TLA156-18	11/16*51	260	500	290
TL156-17	17*51	260	TLA156-19	3/4*55	270	550	325
TL156-18	18*51	265	TLA156-20	25/32*55	270	550	365
TL156-19	19*55	270	TLA156-21	13/16*59	275	550	400
TL156-20	20*55	272	TLA156-22	7/8*59	278	600	450
TL156-21	21*59	275	TLA156-24	15/16*63	286	750	550
TL156-22	22*59	278	TLA156-25	31/32*69	290	750	645
TL156-23	23*63	282	TLA156-26	1*69	290	800	680
TL156-24	24*63	286	TLA156-27	1-1/16*69	294	850	700
TL156-25	25*69	290	TLA156-29	1-1/8*75	297	850	700
TL156-26	26*69	292	TLA156-30	1-3/16*75	300	900	800
TL156-27	27*69	294	TLA156-32	1-1/4*81	310	900	800
TL156-28	28*75	297	TLA156-33	1-5/16*81	325	900	800
TL156-29	29*75	300	TLA156-35	1-3/8*89	330	1000	880
TL156-30	30*75	302	TLA156-37	1-7/16*89	340	1000	880
TL156-32	32*81	310	TLA156-38	1-1/2*89	340	1100	950
TL156-33	33*81	320	TLA156-39	1-9/16*96	350	1100	950
TL156-34	34*81	325	TLA156-44	1-3/4*96	355	1300	1150
TL156-35	35*89	330	TLA156-43	1-11/16*96	355	1300	1150
TL156-36	36*89	330	TLA156-45	1-3/4*105	360	1300	1150
TL156-38	38*89	340	TLA156-46	1-13/16*105	360	1410	1380
TL156-41	41*96	350	TLA156-48	1-7/8*105	365	1410	1380
TL156-42	42*96	355	TLA156-51	2*114	375	1636	1410
TL156-46	46*105	360	TLA156-52	2-1/16*114	375	1984	1710
TL156-47	47*105	365	TLA156-54	2-1/8*120	385	1984	1710
TL156-50	50*114	375	TLA156-56	2-3/16*120	385	3248	2800
TL156-52	52*114	380	TLA156-57	2-1/4*138	395	3248	2800
TL156-54	54*120	385	TLA156-59	2-5/16*138	397	4176	3600
TL156-55	55*120	385	TLA156-60	2-3/8*138	400	4176	3600
TL156-56	56*120	390	TLA156-62	2-7/16*138	400	4176	3600
TL156-58	58*138	395	TLA156-64	2-1/2*150	405	4640	4000
TL156-60	60*138	397	TLA156-65	2-9/16*150	410	4640	4000
TL156-63	63*138	400	TLA156-67	2-5/8*150	410	5568	4800
TL156-65	65*150	405	TLA156-70	2-3/4*150	410	5568	4800
TL156-67	67*150	410	TLA156-71	2-13/16*186	420	5568	4800

TL157 防爆T型套筒扳手



Sliding T-type Wrench



规格及主要技术参数

产品代号 Number	规格(S) mm	长度(L) mm	铍青铜(Be-Cu) g	铝青铜(Al-Cu) g
TL157-7	7	120	100	90
TL157-9	9	130	155	140
TL157-11	11	140	190	170
TL157-14	14	150	265	240
TL157-17	17	170	410	370
TL157-19	19	180	535	480
TL157-22	22	190	750	680
TL157-24	24	200	950	860
TL157-27	27	200	1110	1000
TL157-30	30	200	1340	1210
TL157-32	32	200	1440	1300
TL157-36	36	200	1980	1800

TL157A 防爆加力杆



T-type for box spanner



规格及主要技术参数

产品代号 Number	规格(S) mm	长度(L) mm	铍青铜(Be-Cu) g	铝青铜(Al-Cu) g
TL157A-10	10	150	47	40
TL157A-12	12	190	93	80
TL157A-14	14	200	116	100
TL157A-16	16	250	221	190



TL157B 防爆三角套筒



Socket Wrench, Triangular



规格及主要技术参数

产品代号 Number	规格(S) mm	长度(L) mm	铍青铜(Be-Cu) g	铝青铜(Al-Cu) g
TL157B-06	6	40	75	70
TL157B-08	8	40	80	75
TL157B-10	10	40	85	80
TL157B-12	12	40	95	90
TL157B-16	16	50	180	150
TL157B-20	20	50	250	215
TL157B-24	24	60	470	436

TL157C 防爆加长三角套筒



Socket Wrench Triangular Lengthen

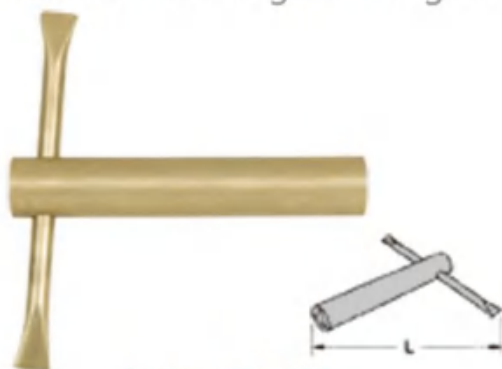

规格及主要技术参数

产品代号 Number	规格(S) mm	长度(L) mm	铍青铜(Be-Cu) g	铝青铜(Al-Cu) g
TL157C-04	4	95	93	80
TL157C-05	5	110	116	100
TL157C-06	6	115	140	170
TL157C-08	8	125	325	280
TL157C-10	10	140	453	390
TL157C-12	12	160	812	700
TL157C-16	16	180	1131	980
TL157C-20	20	200	2436	2100
TL157C-24	24	220	3596	3100

TL157D 防爆双头套筒



Socket Double



规格及主要技术参数

产品代号 Number	规格(S) mm	长度(L) mm	铍青铜(Be-Cu) g	铝青铜(Al-Cu) g
TL157D-0607	6*7	105	70	65
TL157D-0809	8*9	115	90	80
TL157D-1011	10*11	120	110	120
TL157D-1213	12*13	140	170	160
TL157D-1415	14*15	140	255	230
TL157D-1617	16*17	155	440	340
TL157D-1819	18*19	165	520	460
TL157D-2022	20*22	175	630	570
TL157D-2123	21*23	185	670	600
TL157D-2427	24*27	195	870	785
TL157D-2528	25*28	205	965	870
TL157D-2730	27*30	210	1000	900
TL157D-3641	36*41	230	2105	1700

TL157E 防爆加力杆



T-type for box spanner



规格及主要技术参数

产品代号 Number	规格(Φ) mm	长度(L) mm	铍青铜(Be-Cu) g	铝青铜(Al-Cu) g
TL157E-0708	5	110	18	15
TL157E-1011	6	150	47	40
TL157E-1417	10	220	140	120
TL157E-2022	12	300	348	300
TL157E-2427	15	390	557	480
TL157E-3641	16	500	870	750



TL157F 防爆1/2角座扳手

Crow Foot Open End



规格及主要技术参数

产品代号 Number	规格(S) mm	长度(L) mm	铍青铜(Be-Cu) g	铝青铜(Al-Cu) g
TL157F-013	13	40	58	50
TL157F-014	14	40	58	50
TL157F-015	15	43	93	80
TL157F-016	16	43	93	80
TL157F-017	17	43	93	80
TL157F-018	18	49	128	110
TL157F-019	19	49	140	120
TL157F-020	20	49	151	130
TL157F-021	21	52	174	150
TL157F-022	22	52	198	170
TL157F-023	23	52	232	200
TL157F-024	24	55	232	200
TL157F-025	25	55	256	220
TL157F-026	26	59	256	220
TL157F-027	27	59	290	250
TL157F-028	28	59	314	270
TL157F-029	29	63	348	300
TL157F-030	30	63	372	320
TL157F-032	32	67	406	350
TL157F-036	36	76	662	570
TL157F-041	41	86	720	620
TL157F-046	46	97	870	750
TL157F-050	50	105	928	800

TL157G 防爆加长角座扳手

T-Handle Wrench



规格及主要技术参数

产品代号 Number	规格(S) mm	长度(L) mm	铍青铜(Be-Cu) g	铝青铜(Al-Cu) g
TL157G-013	13	160	116	100
TL157G-014	14	160	116	100
TL157G-015	15	200	198	170
TL157G-016	16	200	198	170
TL157G-017	17	200	198	170
TL157G-018	18	200	221	190
TL157G-019	19	200	256	220
TL157G-020	20	200	290	250
TL157G-021	21	200	302	260
TL157G-022	22	200	348	300
TL157G-023	23	200	406	350
TL157G-024	24	250	464	400
TL157G-025	25	250	464	400
TL157G-026	26	250	522	450
TL157G-027	27	250	522	450
TL157G-028	28	250	580	500
TL157G-029	29	250	638	550
TL157G-030	30	250	696	600
TL157G-032	32	250	754	650
TL157G-036	36	250	812	700
TL157G-041	41	315	1346	1150
TL157G-046	46	315	1421	1230
TL157G-050	50	315	1740	1500

TL157H 防爆加力杆

T-type for box spanner



规格及主要技术参数

产品代号 Number	规格(φ) mm	长度(L) mm	铍青铜(Be-Cu) g	铝青铜(Al-Cu) g
TL157H-1315	8	160	82	70
TL157H-1618	10	200	151	130
TL157H-1922	12	200	256	220
TL157H-2327	14	250	464	400
TL157H-2832	16	250	696	600
TL157H-3641	18	315	1160	1000
TL157H-4650	20	315	1856	1600



TL158 防爆六角套筒螺丝刀

Driver Hex Nut



规格及主要技术参数

产品代号 Number	规格(S) mm	长度(L) mm	铍青铜(Be-Cu) g	铝青铜(Al-Cu) g
TL158-3	3	85	65	60
TL158-4	4	85	65	60
TL158-5	5	85	85	81
TL158-6	6	90	85	81
TL158-7	7	90	100	85
TL158-8	8	100	100	85
TL158-10	10	110	140	130
TL158-11	11	110	140	130
TL158-13	13	110	185	172
TL158-14	14	120	185	172
TL158-16	16	130	220	205
TL158-17	17	130	230	218

159-163A 防爆手动套筒头

Socket

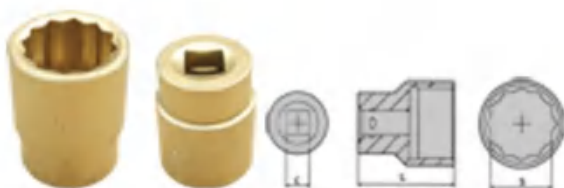

TL159 C=1/4

产品代号 Number	规格(S) mm	长度(L) mm	产品代号 Number	规格(S) mm	长度(L) mm	铍青铜(Be-Cu) g	铝青铜(Al-Cu) g
TL159-4	4	25	159A-4	3/16	25	17	15
TL159-5	5	25	159A-5	7/32	25	17	15
TL159-6	6	25	159A-6	1/4	25	17	15
TL159-8	8	25	159A-7	9/32	25	17	15
TL159-10	10	25	159A-8	5/16	25	22	20
TL159-12	12	26	159A-9	11/32	25	30	25
TL159-13	13	26	159A-10	3/8	25	30	25
TL159-14	14	26	159A-11	7/16	25	35	32
TL159-16	16	27	159A-13	1/2	26	40	36
TL159-17	17	27	159A-14	9/16	26	50	45
TL159-18	18	27				50	45
TL159-19	19	27				51	46

TL160 C=3/8

产品代号 Number	规格(S) mm	长度(L) mm	产品代号 Number	规格(S) mm	长度(L) mm	铍青铜(Be-Cu) g	铝青铜(Al-Cu) g
TL160-5	5	28	TL160A-8	5/16	28	35	32
TL160-55	5.5	28	TL160A-10	3/8	28	35	32
TL160-6	6	28	TL160A-11	7/16	32	35	32
TL160-7	7	28	TL160A-13	1/2	32	35	32
TL160-8	8	28	TL160A-14	9/16	32	35	32
TL160-9	9	28	TL160A-16	5/8	32	35	32
TL160-10	10	32	TL160A-17	11/16	32	50	45
TL160-11	11	32	TL160A-19	3/4	32	50	45
TL160-12	12	32	TL160A-21	13/16	35	50	45
TL160-13	13	32	TL160A-22	7/8	35	50	45
TL160-14	14	32	TL160A-24	15/16	35	50	45
TL160-15	15	32				53	48
TL160-16	16	32				58	53
TL160-17	17	32				63	57
TL160-18	18	32				68	62
TL160-19	19	32				68	62
TL160-20	20	32				77	70
TL160-21	21	32				77	70
TL160-22	22	32				85	75

TL161 C=1/2

产品代号 Number	规格(S) mm	长度(L) mm	产品代号 Number	规格(S) mm	长度(L) mm	铍青铜(Be-Cu) g	铝青铜(Al-Cu) g
TL161-6	6	40	TL161A-8	5/16	40	75	69
TL161-7	7	40	TL161A-10	3/8	40	77	70
TL161-8	8	40	TL161A-11	7/16	40	77	70
TL161-9	9	40	TL161A-13	1/2	40	78	71
TL161-10	10	40	TL161A-14	9/16	40	78	71
TL161-11	11	40	TL161A-15	19/32	40	79	72
TL161-12	12	40	TL161A-16	5/8	40	79	72
TL161-13	13	40	TL161A-17	11/16	40	80	73
TL161-14	14	40	TL161A-19	3/4	42	80	73
TL161-15	15	40	TL161A-20	25/32	43	94	85
TL161-16	16	40	TL161A-21	13/16	43	94	85
TL161-17	17	40	TL161A-22	7/8	43	94	85
TL161-18	18	42	TL161A-24	15/16	43	94	85
TL161-19	19	42	TL161A-25	1	43	110	100
TL161-20	20	42	TL161A-27	1-1/16	46	120	105
TL161-21	21	43	TL161A-29	1-1/8	46	125	110
TL161-22	22	43	TL161A-30	1-3/16	46	130	115
TL161-23	23	43	TL161A-32	1-1/4	46	150	135
TL161-24	24	43				165	145
TL161-25	25	43				180	160
TL161-26	26	43				200	180
TL161-27	27	46				215	190
TL161-28	28	46				225	200
TL161-29	29	46				235	210
TL161-30	30	46				250	220
TL161-31	31	46				295	260
TL161-32	32	46				295	260



TL162 C=3/4

产品代号 Number	规格(S) mm	长度(L) mm	产品代号 Number	规格(S) mm	长度(L) mm	铍青铜 (Be-Cu)g	铝青铜 (Al-Cu)g
TL162-17	17	50	TL162A-17	11/16	50	246	225
TL162-19	19	50	TL162A-19	3/4	50	246	225
TL162-20	20	55	TL162A-22	7/8	55	246	225
TL162-21	21	55	TL162A-25	1	55	268	246
TL162-22	22	55	TL162A-27	1-1/16	55	268	246
TL162-23	23	55	TL162A-30	1-3/16	60	306	280
TL162-24	24	55	TL162A-33	1-5/16	60	307	280
TL162-25	25	55	TL162A-35	1-3/8	60	307	280
TL162-26	26	55	TL162A-36	1-7/16	60	307	280
TL162-27	27	55	TL162A-38	1-1/2	60	312	285
TL162-28	28	55	TL162A-40	1-9/16	60	339	310
TL162-29	29	55	TL162A-41	1-5/8	65	350	320
TL162-30	30	60	TL162A-43	1-11/16	65	410	370
TL162-31	31	60	TL162A-44	1-3/4	65	430	380
TL162-32	32	60	TL162A-46	1-13/16	65	465	410
TL162-34	34	60	TL162A-48	1-7/8	65	480	440
TL162-36	36	60	TL162A-49	1-15/16	65	510	465
TL162-38	38	60	TL162A-51	2	70	555	510
TL162-41	41	65				660	640
TL162-46	46	65				765	690
TL162-50	50	70				910	825
TL162-55	55	70				1100	1009
TL162-60	60	70				1260	1156

TL163 C=1

产品代号 Number	规格(S) mm	长度(L) mm	产品代号 Number	规格(S) mm	长度(L) mm	铍青铜 (Be-Cu)g	铝青铜 (Al-Cu)g
TL163-27	27	55	TL163A-37	1-7/16	65	394	360
TL163-28	28	55	TL163A-38	1-1/2	65	397	363
TL163-29	29	55	TL163A-41	1-5/8	70	399	365
TL163-30	30	60	TL163A-46	1-13/16	70	443	405
TL163-31	31	60	TL163A-51	2	75	448	410
TL163-32	32	60	TL163A-54	2-1/8	75	481	440
TL163-34	34	60	TL163A-60	2-3/8	90	497	455
TL163-36	36	65	TL163A-65	2-9/16	90	550	500
TL163-38	38	65	TL163A-70	2-3/4	90	620	560
TL163-41	41	70	TL163A-75	2-15/16	90	690	625
TL163-46	46	70	TL163A-80	3-1/8	95	850	740
TL163-50	50	75				850	760
TL163-55	55	80				1160	1000
TL163-60	60	85				1390	1260
TL163-65	65	90				1750	1580
TL163-70	70	90				2150	1950
TL163-75	75	95				2680	2430
TL163-80	80	95				3080	2800

164-166A防爆风动套筒头

Impact Socket

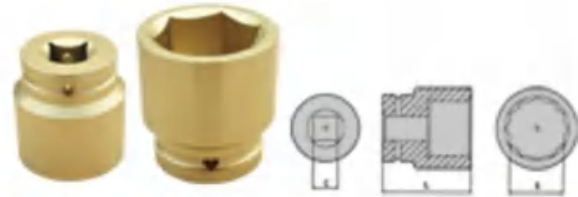

TL164 C=1/2

产品代号 Number	规格(S) mm	长度(L) mm	产品代号 Number	规格(S) mm	长度(L) mm	铍青铜 (Be-Cu)g	铝青铜 (Al-Cu)g
TL164-8	8	40	TL164A-8	5/16	40	85	77
TL164-10	10	40	TL164A-10	3/8	40	86	78
TL164-11	11	40	TL164A-11	7/16	40	87	80
TL164-12	12	40	TL164A-13	1/2	40	87	80
TL164-13	13	40	TL164A-14	9/16	40	88	81
TL164-14	14	40	TL164A-15	19/32	40	88	81
TL164-16	16	40	TL164A-16	5/8	40	104	94
TL164-17	17	40	TL164A-17	11/16	40	104	94
TL164-18	18	42	TL164A-19	3/4	42	104	94
TL164-19	19	42	TL164A-20	25/32	42	121	110
TL164-21	21	43	TL164A-21	13/16	43	138	121
TL164-22	22	43	TL164A-22	7/8	43	143	127
TL164-24	24	43	TL164A-24	15/16	43	182	160
TL164-27	27	46	TL164A-25	1	43	237	209
TL164-28	28	46	TL164A-27	1-1/16	46	248	220
TL164-30	30	46	TL164A-29	1-1/8	46	275	242
TL164-32	32	46	TL164A-30	1-3/16	46	325	286
			TL164A-32	1-1/4	46		

TL165 C=3/4

产品代号 Number	规格(S) mm	长度(L) mm	产品代号 Number	规格(S) mm	长度(L) mm	铍青铜 (Be-Cu)g	铝青铜 (Al-Cu)g
TL165-24	24	55	TL165A-25	1	55	380	330
TL165-27	27	55	TL165A-27	1-1/16	55	405	365
TL165-30	30	60	TL165A-30	1-3/16	60	440	390
TL165-32	32	60	TL165A-33	1-5/16	60	475	425
TL165-36	36	60	TL165A-37	1-7/16	60	650	585
TL165-38	38	60	TL165A-38	1-1/2	60	695	625
TL165-41	41	65	TL165A-41	1-5/8	65	695	625
TL165-46	46	65	TL165A-46	1-13/16	65	770	700
TL165-50	50	70	TL165A-50	1-15/16	65	1100	1000
TL165-55	55	70				1472	1350
TL165-60	60	75				1886	1730
TL165-65	65	70				2344	2150



TL166 C=1

产品代号 Number	规格(S) mm	长度(L) mm	产品代号 Number	规格(S) mm	长度(L) mm	铍青铜 (Be-Cu)g	铝青铜 (Al-Cu)g
TL166-19	19	55	TL166A-19	3/4	55	630	570
TL166-21	21	55	TL166A-21	13/16	55	640	580
TL166-22	22	55	TL166A-22	7/8	55	650	590
TL166-24	24	55	TL166A-25	1	55	660	600
TL166-26	26	55	TL166A-27	1-1/16	55	735	660
TL166-27	27	55	TL166A-29	1-1/8	60	735	670
TL166-30	30	60	TL166A-30	1-3/16	60	765	690
TL166-32	32	60	TL166A-33	1-5/16	60	775	700
TL166-34	34	60	TL166A-35	1-3/8	60	775	700
TL166-36	36	65	TL166A-37	1-7/16	65	775	700
TL166-38	38	65	TL166A-38	1-1/2	65	865	780
TL166-41	41	70	TL166A-41	1-5/8	65	930	830
TL166-46	46	70	TL166A-44	1-3/4	70	1380	1265
TL166-50	50	75	TL166A-46	1-13/16	70	1455	1320
TL166-55	55	80	TL166A-49	1-15/16	75	1830	1650
TL166-60	60	85	TL166A-51	2	75	2200	2000
TL166-65	65	90	TL166A-54	2-1/8	80	2460	2250
TL166-70	70	90	TL166A-60	2-3/8	80	2890	2600
TL166-75	75	95	TL166A-65	2-9/16	90	3155	2900
TL166-80	80	95	TL166A-70	2-3/4	90	3560	3200
			TL166A-75	2-15/16	90		
			TL166A-80	3-1/8	95		

TL167防爆换向棘轮扳手

Ratchet Wrench

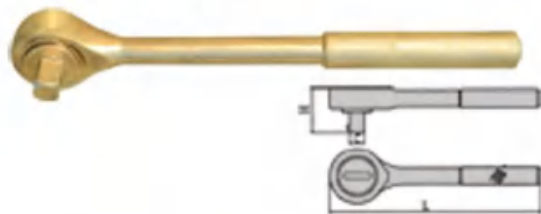

规格及主要技术参数

产品代号 Number	规格(S) mm	长度(L) mm	铍青铜(Be-Cu) g	铝青铜(Al-Cu) g
TL167-6	1/4" *130	130	260	230
TL167-10	3/8" *200	200	290	260
TL167-13	1/2" *250	250	690	615
TL167-19	3/4" *320	320	1570	1430
TL167-25	1" *500	500	3470	3150

TL167A防爆换向棘轮扳手

Ratchet Wrench



规格及主要技术参数

产品代号 Number	规格(S) mm	长度(L) mm	铍青铜(Be-Cu) g	铝青铜(Al-Cu) g
TL167A-019	3/4"	160	1760	1600
TL167A-025	1"	180	2470	2250

TL168防爆方孔棘轮扳手

Ratchet Wrench



规格及主要技术参数

产品代号 Number	规格(S) mm	长度(L) mm	铍青铜(Be-Cu) g	铝青铜(Al-Cu) g
TL168-6	1/4" *130	130	350	305
TL168-10	3/8" *200	200	400	360
TL168-13	1/2" *250	250	535	480
TL168-19	3/4" *320	320	1290	1170
TL168-20	3/4" *125	125	1200	1100
TL168-25	1" *125	125	1590	1440

TL169防爆快速摇柄

Speed Handle

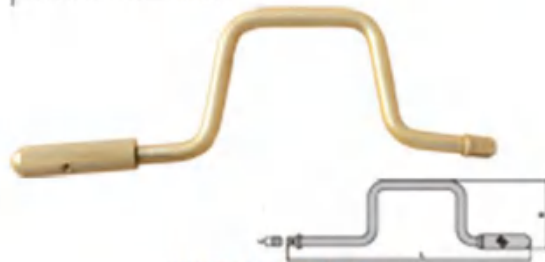

规格及主要技术参数

产品代号 Number	规格(S) mm	长度(L) mm	铍青铜(Be-Cu) g	铝青铜(Al-Cu) g
TL169-10	3/8" *400	400	620	550
TL169-13	1/2" *420	420	780	700



TL170防爆滑行头手柄

Sliding T Handle



规格及主要技术参数

产品代号 Number	规格(S) mm	长度(L) mm	铍青铜(Be-Cu) g	铝青铜(Al-Cu) g
TL170-10	3/8" *200	200	330	303
TL170-13	1/2" *250	250	340	310
TL170-19	3/4" *320	320	1070	960
TL170-25	1" *500	500	1620	1481

TL170A防爆T型滑行头加力

Sliding T Handle



规格及主要技术参数

产品代号 Number	规格(S) mm	长度(L) mm	铍青铜(Be-Cu) g	铝青铜(Al-Cu) g
TL170A-13	1/2"	220	1625	1491
TL170A-19	3/4"	250	1705	1550
TL170A-25	1"	300	2590	2350

TL171防爆换向手柄

Hinged Handle



规格及主要技术参数

产品代号 Number	规格(S) mm	长度(L) mm	铍青铜(Be-Cu) g	铝青铜(Al-Cu) g
TL171-06	1/4" *150	150	215	198
TL171-10	3/8" *200	200	245	220
TL171-13	1/2" *250	250	440	400
TL171-19	3/4" *286	286	635	570

TL171A防爆T型换向手柄

Hinged T Handle



规格及主要技术参数

产品代号 Number	规格(S) mm	长度(L) mm	铍青铜(Be-Cu) g	铝青铜(Al-Cu) g
TL171A-13	1/2"	460	610	580
TL171A-19	3/4"	560	965	899
TL171A-25	1"	660	1360	1260

TL172防爆弯柄

Offset handle



规格及主要技术参数

产品代号 Number	规格(S) mm	长度(L) mm	铍青铜(Be-Cu) g	铝青铜(Al-Cu) g
TL172-10	3/8" *200	200	314	287
TL172-13	1/2" *250	250	410	380

TL173防爆旋具手柄

Diver Type Handle



规格及主要技术参数

产品代号 Number	规格(S) mm	长度(L) mm	铍青铜(Be-Cu) g	铝青铜(Al-Cu) g
TL173-6	1/4" *140	140	95	85
TL173-10	3/8" *160	160	175	165



TL173A防爆1/2' 方一字旋具

Slotted Screwdriver Socket



规格及主要技术参数

产品代号 Number	规格(S) mm	长度(L) mm	铍青铜(Be-Cu) g	铝青铜(Al-Cu) g
TL173A-04	4	60	163	140
TL173A-06	6	60	163	140
TL173A-08	8	60	163	140
TL173A-10	10	60	163	140

TL173B 防爆1/2' 方十字旋具

Phillips Screwdriver Socket



规格及主要技术参数

产品代号 Number	规格(S) mm	长度(L) mm	铍青铜(Be-Cu) g	铝青铜(Al-Cu) g
TL173B-04	4	60	163	140
TL173B-06	6	60	163	140
TL173B-08	8	60	163	140
TL173B-10	10	60	163	140

TL173D防爆1/2' 加长六角旋具

Internal Hex Socket Lengthen



规格及主要技术参数

产品代号 Number	规格(S) mm	长度(L) mm	铍青铜(Be-Cu) g	铝青铜(Al-Cu) g
TL173D-1205	5	90	105	90
TL173D-1206	5	180	145	125
TL173D-1207	6	90	93	80
TL173D-1208	6	140	140	120
TL173D-1209	6	160	157	135
TL173D-1210	7	100	105	90
TL173D-1211	8	90	105	90
TL173D-1212	8	120	123	105
TL173D-1213	10	140	174	150
TL173D-1214	12	140	221	190
TL173D-1215	14	140	290	250

TL173C防爆1/2' 3/4' 1'六角旋具

Internal Hex Socket



规格及主要技术参数

产品代号 Number	规格(S) mm	长度(L) mm	铍青铜(Be-Cu) g	铝青铜(Al-Cu) g
TL173C-1204	4	60	76	65
TL173C-1206	6	60	82	70
TL173C-1208	8	60	93	80
TL173C-1210	10	60	110	95
TL173C-1212	12	60	134	115
TL173C-1214	14	60	169	145
TL173C-1217	17	60	238	205
TL173C-1219	19	60	267	230
TL173C-3414	14	80	406	350
TL173C-3417	17	80	453	390
TL173C-3419	19	80	505	435
TL173C-3422	22	80	557	480
TL173C-3424	24	80	604	520
TL173C-3427	27	80	638	550
TL173C-3430	30	80	662	570
TL173C-3432	32	80	685	590
TL173C-3436	36	90	720	620
TL173C-1017	17	90	673	580
TL173C-1019	19	90	778	670
TL173C-1022	22	90	824	710
TL173C-1024	24	90	894	770
TL173C-1027	27	90	998	860
TL173C-1030	30	90	1056	910
TL173C-1032	32	90	1102	950
TL173C-1036	36	100	1149	990

TL174防爆套筒连接杆

Driver Extension



规格及主要技术参数

产品代号 Number	规格(S) mm	长度(L) mm	铍青铜(Be-Cu) g	铝青铜(Al-Cu) g
TL174-6	1/4" *100	100	75	70
TL174-9	3/8" *125	120	93	80
TL174-10	3/8" *250	250	185	160
TL174-12	1/2" *125	125	260	230
TL174-13	1/2" *250	250	470	330
TL174-19	3/4" *200	200	855	770
TL174-20	3/4" *280	280	890	810
TL174-25	1" *220	220	1525	1380



TL174A防爆Z套筒连接杆

Drivier Extension



规格及主要技术参数

产品代号 Number	规格(S) mm	长度(L) mm	铍青铜(Be-Cu) g	铝青铜(Al-Cu) g
TL174A-0150	1/2	150	232	200
TL174A-0250	1/2	250	464	400

TL175防爆万向节

Universal Joint



规格及主要技术参数

产品代号 Number	规格(S) mm	长度(L) mm	铍青铜(Be-Cu) g	铝青铜(Al-Cu) g
TL175-6	1/4" *40	40	65	55
TL175-10	3/8" *68	68	65	55
TL175-13	1/2" *75	75	186	170
TL175-19	3/4" *100	100	530	480
TL175-25	1" *135	135	1000	900

TL176防爆旋具接头

Screwdriver Socket



规格及主要技术参数

产品代号 Number	规格(S) mm	长度(L) mm	铍青铜(Be-Cu) g	铝青铜(Al-Cu) g
TL176-10	3/8" *48	48	98	89
TL176-13	1/2" *52	52	102	91

TL180防爆转向接头

Flex Ball Joint

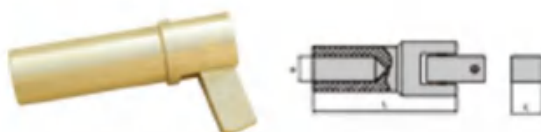

规格及主要技术参数

产品代号 Number	规格(S) mm	长度(L) mm	铍青铜(Be-Cu) g	铝青铜(Al-Cu) g
TL180-19	3/4" *120	120	880	800
TL180-25	1" *120	120	1160	1050

TL177防爆直接头

Straight Joint



规格及主要技术参数

产品代号 Number	规格(S) mm	长度(L) mm	铍青铜(Be-Cu) g	铝青铜(Al-Cu) g
TL177-6	1/4" *25	25	10	8
TL177-10	3/8" *28	28	29	25
TL177-13	1/2" *38	38	54	46
TL177-19	3/4" *52	52	157	135
TL177-25	1" *60	60	377	325

TL178防爆变径接头

Adaptor



规格及主要技术参数

产品代号 Number	规格(S) mm	长度(L) mm	铍青铜(Be-Cu) g	铝青铜(Al-Cu) g
TL178-6	1/4" *3/8"	26	22	20
TL178-9	3/8" *1/4"	26	31	28
TL178-10	3/8" *1/2"	34	60	55
TL178-12	1/2" *3/8"	34	80	70
TL178-13	1/2" *3/4"	50	170	150
TL178-19	3/4" *1/2"	55	290	260
TL178-20	3/4" *1"	60	360	320
TL178-25	1" *3/4"	70	855	770

TL179防爆加长火花塞套筒

Spark Plug Socket



规格及主要技术参数

产品代号 Number	规格(S) mm	长度(L) mm	铍青铜(Be-Cu) g	铝青铜(Al-Cu) g
TL179-9	3/8" *5/8"	40	150	130
TL179-10	3/8" *13/16"	45	180	160
TL179-12	1/2" *5/8"	50	130	115
TL179-13	1/2" *13/16"	55	160	145

TIANLONG 天龙防爆工具
高精品质 全国领先地位



防爆钳子系列

专业制造商

TIANLONG

TIANLONG



TL181 防爆克丝钳

Pliers, Combination



规格及主要技术参数

产品代号 Number	规格(S) mm	长度(L) mm	铍青铜(Be-Cu) g	铝青铜(Al-Cu) g
TL181-0160	150	150	180	165
TL181-0180	180	180	355	330
TL181-0200	200	200	465	435

TL183 防爆水泵钳

Pliers, Groove Joint



规格及主要技术参数

产品代号 Number	规格(S) mm	长度(L) mm	铍青铜(Be-Cu) g	铝青铜(Al-Cu) g
TL183-0225	225	225	425	370
TL183-0250	250	250	425	370
TL183-0300	300	300	670	600

TL182 防爆鲤鱼钳

Pliers, Adjustable Combination



规格及主要技术参数

产品代号 Number	规格(S) mm	长度(L) mm	铍青铜(Be-Cu) g	铝青铜(Al-Cu) g
TL182-0160	150	150	213	195
TL182-0200	200	200	380	350

TL184 防爆尖嘴钳

Pliers, Long Nose



规格及主要技术参数

产品代号 Number	规格(S) mm	长度(L) mm	铍青铜(Be-Cu) g	铝青铜(Al-Cu) g
TL184-0160	150	150	190	170
TL184-0200	200	200	335	300

TL182A 防爆煤气管钳

Gas Pliers



规格及主要技术参数

产品代号 Number	规格(S) mm	长度(L) mm	铍青铜(Be-Cu) g	铝青铜(Al-Cu) g
TL182A-0200	200	200	350	315

TL184A 防爆弯型尖嘴钳

Pliers, Round 45 Degree Bent



规格及主要技术参数

产品代号 Number	规格(S) mm	长度(L) mm	铍青铜(Be-Cu) g	铝青铜(Al-Cu) g
255A-0150	150	150	190	170
255A-0200	200	200	335	300



TL185 防爆鸭嘴钳

Pliers, Flat Nose



规格及主要技术参数

产品代号 Number	规格(S) mm	长度(L) mm	铍青铜(Be-Cu) g	铝青铜(Al-Cu) g
TL185-0160	150	150	165	151
TL185-0180	200	200	281	257

TL186 防爆圆嘴钳

Pliers, Round Nose



规格及主要技术参数

产品代号 Number	规格(S) mm	长度(L) mm	铍青铜(Be-Cu) g	铝青铜(Al-Cu) g
TL186-0160	150	150	165	151
TL186-0180	200	200	281	257

TL187 防爆外挡钳

Pliers, Snap Ring-External



规格及主要技术参数

产品代号 Number	规格(S) mm	长度(L) mm	铍青铜(Be-Cu) g	铝青铜(Al-Cu) g
TL187-0175	200	200	290	265
TL187-0225	250	150	415	380

TL188 防爆内挡钳

Pliers, Snap Ring-Internal



规格及主要技术参数

产品代号 Number	规格(S) mm	长度(L) mm	铍青铜(Be-Cu) g	铝青铜(Al-Cu) g
TL188-0175	200	200	290	265
TL188-0225	250	250	415	380

TL189 防爆斜嘴钳

Pliers, Diagonal Cutting



规格及主要技术参数

产品代号 Number	规格(S) mm	长度(L) mm	铍青铜(Be-Cu) g	铝青铜(Al-Cu) g
TL189-0160	150	150	245	225
TL189-0200	200	200	410	365

TL190 防爆剥线钳

Wire Stripping Pliers



规格及主要技术参数

产品代号 Number	规格(S) mm	长度(L) mm	铍青铜(Be-Cu) g	铝青铜(Al-Cu) g
TL190-0170	170	170	225	205



TL190A 防爆剥线 压线 断线钳

Crimping Tool, Insulated Cable Connectors

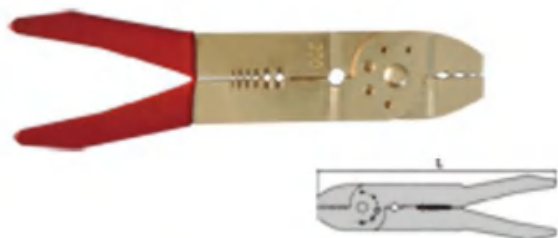

规格及主要技术参数

产品代号 Number	规格(S) mm	长度(L) mm	铍青铜(Be-Cu) g	铝青铜(Al-Cu) g
TL190A-0170	8	200	225	205

TL192A 防爆钳子组合4件套

Pliers, Set



规格及主要技术参数

产品代号 Number	规格(S) mm	铍青铜(Be-Cu) g	铝青铜(Al-Cu) g
TL192A-004	200	1635	1410
	165		
	180		
	250		

TL191 防爆顶切钳

Pincers



规格及主要技术参数

产品代号 Number	规格(S) mm	长度(L) mm	铍青铜(Be-Cu) g	铝青铜(Al-Cu) g
TL191-0175	175	175	250	225

TL193 防爆链式管钳B型

Wrench, Chain Pipe



规格及主要技术参数

产品代号 Number	规格(S) mm	长度(L) mm	铍青铜(Be-Cu) g	铝青铜(Al-Cu) g
TL193-0600	600	600	4650	4200
TL193-0900	900	900	9810	9000

TL192 防爆胡桃钳

Pincers



规格及主要技术参数

产品代号 Number	规格(S) mm	长度(L) mm	铍青铜(Be-Cu) g	铝青铜(Al-Cu) g
TL192-0200	200	200	325	300

TL193A 防爆链式管钳A型

Wrench, Chain Pipe Light



规格及主要技术参数

产品代号 Number	规格(S) mm	长度(L) mm	铍青铜(Be-Cu) g	铝青铜(Al-Cu) g
TL193A-0600	600	600	2105	1910
TL193A-0900	900	900	10500	9500

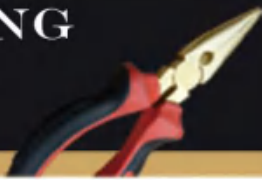

TL194 防爆断线钳



Bolt Chipper



规格及主要技术参数

产品代号 Number	规格(S) mm	长度(L) mm	铍青铜(Be-Cu) g	铝青铜(Al-Cu) g
TL194-0450	450	450	3120	2863
TL194-0600	600	600	3350	3070
TL194-0900	900	900	9250	8400

TL194A 防爆瑞士水泵钳45°



Wrench,Swedish Type 45°



规格及主要技术参数

产品代号 Number	规格(S)	长度(L) mm	铍青铜(Be-Cu) g	铝青铜(Al-Cu) g
TL194A-025	1"	200	820	720
TL194A-038	1-1/2"	300	1570	1400
TL194A-050	2"	350	3200	2800
TL194A-075	3"	600	4100	3650
TL194A-100	4"	900	6200	5400

TL194B 防爆瑞士水泵钳90°



Wrench,Swedish Type 90°



规格及主要技术参数

产品代号 Number	规格(S) mm	长度(L) mm	铍青铜(Be-Cu) g	铝青铜(Al-Cu) g
TL194B-038	1-1/2"	435	1570	1400
TL194B-050	2"	540	3200	2800

TL194C 防爆S型瑞士水泵钳



Wrench,Swedish Type

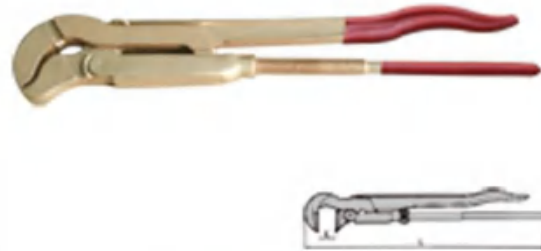

规格及主要技术参数

产品代号 Number	规格(S) mm	长度(L) mm	铍青铜(Be-Cu) g	铝青铜(Al-Cu) g
TL194C-25	1"	350	1500	1400
TL194C-50	2"	530	2605	2355
TL194C-75	3"	650	4500	4060
TL194C-100	4"	790	6200	5600

TL195 防爆管钳



Wrench,Pipe

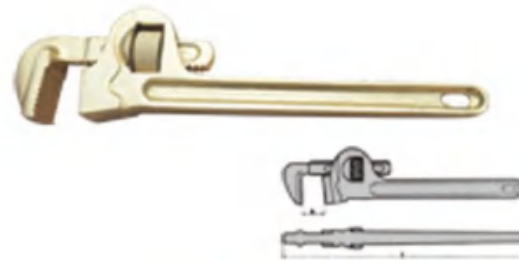

规格及主要技术参数

产品代号 Number	规格(S) mm	长度(L) mm	铍青铜(Be-Cu) g	铝青铜(Al-Cu) g
TL195-0150	150*20	150	300	260
TL195-0200	200*25	200	380	345
TL195-0250	250*30	250	580	500
TL195-0300	300*40	300	750	680
TL195-0350	350*50	350	1100	1000
TL195-0450	450*60	450	1785	1625
TL195-0600	600*75	600	3255	2960
TL195-0900	900*85	900	6035	5490
TL195-1200	1200*110	1200	12280	10870



TL195A 防爆美式重型管钳

Wrench, Pipe (American Type)

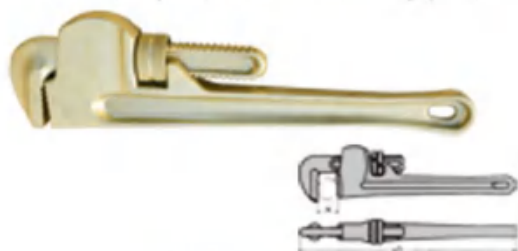

规格及主要技术参数

产品代号 Number	规格(S) mm	长度(L) mm	铍青铜(Be-Cu) g	铝青铜(Al-Cu) g
TL195A-0150	150*20	150	380	350
TL195A-0200	200*25	200	420	380
TL195A-0250	250*30	250	735	670
TL195A-0300	300*40	300	1050	955
TL195A-0350	350*50	350	1315	1195
TL195A-0450	450*60	450	2255	2050
TL195A-0600	600*75	600	3465	3150
TL195A-0900	900*85	900	5880	5345
TL195A-1200	1200*110	1200	12600	11450

TL195B 防爆英式管钳

Wrench, Pipe (English-type)



规格及主要技术参数

产品代号 Number	规格(S) mm	长度(L) mm	铍青铜(Be-Cu) g	铝青铜(Al-Cu) g
TL195B-0150	150*20	150	300	260
TL195B-0200	200*25	200	380	345
TL195B-0250	250*30	250	580	500
TL195B-0300	300*40	300	750	680
TL195B-0350	350*50	350	1100	1000
TL195B-0450	450*60	450	1785	1625
TL195B-0600	600*75	600	3255	2960
TL195B-0900	900*85	900	6035	5490
TL195B-1200	1200*110	1200	12280	10870

TL196 防爆皮带管钳

Wrench, Belt Pipe



规格及主要技术参数

产品代号 Number	规格(S) mm	长度(L) mm	铍青铜(Be-Cu) g	铝青铜(Al-Cu) g
TL196-0300	30	300	810	735

TL197 防爆镊子

Tweezers



规格及主要技术参数

产品代号 Number	规格(S) mm	长度(L) mm	铍青铜(Be-Cu) g	铝青铜(Al-Cu) g
TL197-0160	160	160	30	25
TL197-0200	200	200	50	40

TL197A 防爆镊子

Tweezers



规格及主要技术参数

产品代号 Number	规格(S) mm	长度(L) mm	铍青铜(Be-Cu) g	铝青铜(Al-Cu) g
TL197A-100	100	100	50	40

TL197B 防爆镊子

Tweezers



规格及主要技术参数

产品代号 Number	规格(S) mm	长度(L) mm	铍青铜(Be-Cu) g	铝青铜(Al-Cu) g
TL197B-150	150	150	30	25

TIANLONG 天龙防爆工具
高精品质 全国领先品牌



防爆锤子系列

专业制造商

TIANLONG

TIANLONG



TL198 防爆木柄机械锤

Hammer, Cross Pein Engineers



规格及主要技术参数

产品代号 Number	规格(H) kg	长度(L) mm	铍青铜(Be-Cu) g	铝青铜(Al-Cu) g
TL198-0500	0.5kg	310	600	600
TL198-1000	1kg	340	1100	1100
TL198-1500	1.5kg	400	1700	1700
TL198-1800	1.8kg	450	2100	2100
TL198-3000	3kg	900	3600	3600
TL198-5000	5kg	900	5700	5700

TL199A 防爆塑柄羊角锤

Hammer, Claw



规格及主要技术参数

产品代号 Number	规格(H) kg	长度(L) mm	铍青铜(Be-Cu) g	铝青铜(Al-Cu) g
TL199A-0250	0.25	280	350	350
TL199A-0450	0.45	300	520	520
TL199A-0750	0.75	330	930	930

TL198A 防爆塑柄机械锤

Hammer, Cross Pein Engineers



规格及主要技术参数

产品代号 Number	规格(H) kg	长度(L) mm	铍青铜(Be-Cu) g	铝青铜(Al-Cu) g
TL198A-0500	0.5	310	600	600
TL198A-1000	1	340	1100	1100
TL198A-1500	1.5	400	1700	1700
TL198A-1800	1.8	450	2100	2100
TL198A-3000	3	900	3600	3600
TL198A-5000	5	900	5700	5700

TL199B 防爆木柄美式羊角锤

Hammer, Claw(American type)



规格及主要技术参数

产品代号 Number	规格(H) kg	长度(L) mm	铍青铜(Be-Cu) g	铝青铜(Al-Cu) g
TL199B-0300	300	310	440	440
TL199B-0400	400	340	540	540
TL199B-0500	500	340	640	640
TL199B-0600	600	340	740	740

TL199 防爆木柄羊角锤

Hammer, Claw



规格及主要技术参数

产品代号 Number	规格(H) kg	长度(L) mm	铍青铜(Be-Cu) g	铝青铜(Al-Cu) g
TL199-0250	0.25	280	350	350
TL199-0450	0.45	300	520	520
TL199-0750	0.75	330	930	930

TL199C 防爆塑柄美式羊角锤

Hammer, Claw(American type)



规格及主要技术参数

产品代号 Number	规格(H) kg	长度(L) mm	铍青铜(Be-Cu) g	铝青铜(Al-Cu) g
TL199C-0300	300	310	440	440
TL199C-0400	400	340	540	540
TL199C-0500	500	340	640	640
TL199C-0600	600	340	740	740



TL200 防爆木柄除锈锤

Hammer,Scaling



规格及主要技术参数

产品代号 Number	规格(H) kg	长度(L) mm	铍青铜(Be-Cu) g	铝青铜(Al-Cu) g
TL200-0150	0.15	280	205	205
TL200-0220	0.22	280	280	280
TL200-0450	0.45	280	680	680
TL200-0680	0.68	300	950	950
TL200-1360	1.36	300	1650	1650

TL200A 铜木柄除锈锤

Copper Hammer,Scaling

产品代号 Number	规格(H) kg	长度(L) mm	紫铜(Copper) g	黄铜(Brass) g
TL200A-0150	0.15	280	205	205
TL200A-0220	0.22	280	280	280
TL200A-0450	0.45	280	680	680
TL200A-0680	0.68	300	950	950
TL200A-1360	1.36	300	1650	1650

TL200B 防爆塑柄除锈锤

Hammer,Scaling



规格及主要技术参数

产品代号 Number	规格(H) kg	长度(L) mm	铍青铜(Be-Cu) g	铝青铜(Al-Cu) g
TL200B-0150	0.15	280	220	220
TL200B-0220	0.22	280	310	310
TL200B-0450	0.45	280	720	720
TL200B-0680	0.68	300	980	980
TL200B-1360	1.36	300	1780	1780

TL200C 铜塑柄除锈锤

Copper Hammer,Scaling

产品代号 Number	规格(H) kg	长度(L) mm	紫铜(Copper) g	黄铜(Brass) g
TL200C-0150	0.15	280	220	220
TL200C-0220	0.22	280	310	310
TL200C-0450	0.45	280	720	720
TL200C-0680	0.68	300	980	980
TL200C-1360	1.36	300	1780	1780

TL201 防爆木柄圆头锤

Hammer,Ball Pein



规格及主要技术参数

产品代号 Number	规格(H) kg	长度(L) mm	铍青铜(Be-Cu) g	铝青铜(Al-Cu) g
TL201-230	230	280	403	403
TL201-340	340	280	502	502
TL201-450	450	310	680	680
TL201-680	680	340	950	950
TL201-910	910	350	1205	1205
TL201-1130	1130	400	1470	1470

TL201A 铜木柄圆头锤

Copper Hammer,Ball Pein

产品代号 Number	规格(H) kg	长度(L) mm	紫铜(Copper) g	黄铜(Brass) g
TL201A-230	230	280	403	403
TL201A-340	340	280	502	502
TL201A-450	450	310	680	680
TL201A-680	680	340	950	950
TL201A-910	910	350	1205	1205
TL201A-1130	1130	400	1470	1470

TL201B 防爆塑柄圆头锤

Hammer,Ball Pein



规格及主要技术参数

产品代号 Number	规格(H) kg	长度(L) mm	铍青铜(Be-Cu) g	铝青铜(Al-Cu) g
TL201B-230	230	280	403	403
TL201B-340	340	280	502	502
TL201B-450	450	310	680	680
TL201B-680	680	340	950	950
TL201B-910	910	350	1205	1205
TL201B-1130	1130	400	1470	1470

TL201C 铜塑柄圆头锤

Copper Hammer,Ball Pein

产品代号 Number	规格(H) kg	长度(L) mm	紫铜(Copper) g	黄铜(Brass) g
TL201C-230	230	280	403	403
TL201C-340	340	280	502	502
TL201C-450	450	310	680	680
TL201C-680	680	340	950	950
TL201C-910	910	350	1205	1205
TL201C-1130	1130	400	1470	1470



TL201D 防爆木柄双头圆头锤

Hammer, Double Ball Pein



规格及主要技术参数

产品代号 Number	规格(H) kg	长度(L) mm	铍青铜(Be-Cu) g	铝青铜(Al-Cu) g
TL201D-100	100	310	250	250
TL201D-150	150	310	250	250
TL201D-200	200	310	250	250
TL201D-300	300	310	450	450
TL201D-400	400	340	560	560
TL201D-500	500	340	660	660
TL201D-600	600	340	760	760
TL201D-700	700	340	850	850
TL201D-800	800	380	960	960
TL201D-900	900	380	1050	1050
TL201D-1000	1000	380	1170	1170
TL201D-1300	1300	400	1470	1470
TL201D-1500	1500	400	1670	1670
TL201D-2000	2000	400	2180	2180

TL201E 防爆塑柄双头圆头锤

Hammer, Double Ball Pein



规格及主要技术参数

产品代号 Number	规格(H) kg	长度(L) mm	铍青铜(Be-Cu) g	铝青铜(Al-Cu) g
TL201E-100	100	310	250	250
TL201E-150	150	310	250	250
TL201E-200	200	310	250	250
TL201E-300	300	310	450	450
TL201E-400	400	340	560	560
TL201E-500	500	340	660	660
TL201E-600	600	340	760	760
TL201E-700	700	340	850	850
TL201E-800	800	380	960	960
TL201E-900	900	380	1050	1050
TL201E-1000	1000	380	1170	1170
TL201E-1300	1300	400	1470	1470
TL201E-1500	1500	400	1670	1670
TL201E-2000	2000	400	2180	2180

TL202 防爆木柄砖瓦锤

Hammer, Bricklayers



规格及主要技术参数

产品代号 Number	规格(H) kg	长度(L) mm	铍青铜(Be-Cu) g	铝青铜(Al-Cu) g
TL202-0600	0.6	305	780	780
TL202-0800	0.8	340	1000	1000

TL202A 防爆塑柄砖瓦锤

Hammer, Bricklayers



规格及主要技术参数

产品代号 Number	规格(H) kg	长度(L) mm	铍青铜(Be-Cu) g	铝青铜(Al-Cu) g
TL202A-0600	0.6	305	780	780
TL202A-0800	0.8	340	1000	1000

TL203 防爆木柄双面锤

Hammer, Club



规格及主要技术参数

产品代号 Number	规格(H) kg	长度(L) mm	铍青铜(Be-Cu) g	铝青铜(Al-Cu) g
TL203-0800	0.8	400	960	960
TL203-1020	1.02	400	1170	1170
TL203-1250	1.25	400	1470	1470
TL203-1360	1.36	400	1670	1670

TL203A 防爆塑柄双面锤

Hammer, Club



规格及主要技术参数

产品代号 Number	规格(H) kg	长度(L) mm	铍青铜(Be-Cu) g	铝青铜(Al-Cu) g
TL203A-0800	0.8	400	960	960
TL203A-1020	1.02	400	1170	1170
TL203A-1250	1.25	400	1470	1470
TL203A-1360	1.36	400	1670	1670



TL204 防爆德式木柄八角锤

Hammer, Sledge (German Type)



规格及主要技术参数

产品代号 Number	规格(H) kg	长度(L) mm	铍青铜(Be-Cu) g	铝青铜(Al-Cu) g
TL204-1000	1	400	1300	1300
TL204-1250	1.25	400	1550	1550
TL204-1500	1.5	400	1800	1800
TL204-2000	2	400	2300	2300
TL204-2500	2.5	900	3200	3200
TL204-3000	3	900	3900	3900
TL204-4000	4	900	4900	4900
TL204-5000	5	900	5900	5900
TL204-6000	6	900	6900	6900
TL204-8000	8	900	8900	8900
TL204-10000	10	900	10900	10900

TL204A 铜德式木柄八角锤

Copper Hammer, Sledge (German Type)

产品代号 Number	规格(H) kg	长度(L) mm	紫铜(Copper) g	黄铜(Brass) g
TL204A-1000	1	400	1300	1300
TL204A-1250	1.25	400	1550	1550
TL204A-1500	1.5	400	1800	1800
TL204A-2000	2	400	2300	2300
TL204A-2500	2.5	900	3200	3200
TL204A-3000	3	900	3900	3900
TL204A-4000	4	900	4900	4900
TL204A-5000	5	900	5900	5900
TL204A-6000	6	900	6900	6900
TL204A-8000	8	900	8900	8900
TL204A-10000	10	900	10900	10900

TL204B 防爆德式塑柄八角锤

Hammer, Sledge (German Type)



规格及主要技术参数

产品代号 Number	规格(H) kg	长度(L) mm	铍青铜(Be-Cu) g	铝青铜(Al-Cu) g
TL204B-1000	1	400	1300	1300
TL204B-1250	1.25	400	1550	1550
TL204B-1500	1.5	400	1800	1800
TL204B-2000	2	400	2300	2300
TL204B-2500	2.5	900	3200	3200
TL204B-3000	3	900	3900	3900
TL204B-4000	4	900	4900	4900
TL204B-5000	5	900	5900	5900
TL204B-6000	6	900	6900	6900
TL204B-8000	8	900	8900	8900
TL204B-10000	10	900	10900	10900

TL204C 铜德式塑柄八角锤

Copper Hammer, Sledge (German Type)

产品代号 Number	规格(H) kg	长度(L) mm	紫铜(Copper) g	黄铜(Brass) g
TL204C-1000	1	400	1300	1300
TL204C-1250	1.25	400	1550	1550
TL204C-1500	1.5	400	1800	1800
TL204C-2000	2	400	2300	2300
TL204C-2500	2.5	900	3200	3200
TL204C-3000	3	900	3900	3900
TL204C-4000	4	900	4900	4900
TL204C-5000	5	900	5900	5900
TL204C-6000	6	900	6900	6900
TL204C-8000	8	900	8900	8900
TL204C-10000	10	900	10900	10900

TL205 防爆木柄八角锤

Hammer, Sledge



规格及主要技术参数

产品代号 Number	规格(H) kg	长度(L) mm	铍青铜(Be-Cu) g	铝青铜(Al-Cu) g
TL205-0900	0.9	400	1200	1200
TL205-1400	1.4	400	1700	1700
TL205-1800	1.8	400	2100	2100
TL205-2700	2.7	900	3710	3710
TL205-3600	3.6	900	4910	4910
TL205-4500	4.5	900	5410	5410
TL205-5400	5.4	900	6310	6310
TL205-6300	6.3	900	7310	7310
TL205-7200	7.2	900	8110	8110
TL205-8100	8.1	900	8910	8910
TL205-9000	9	900	10010	10010
TL205-10000	10	900	10810	10810

TL205A 铜木柄八角锤

Copper Hammer, Sledge

产品代号 Number	规格(H) kg	长度(L) mm	紫铜(Copper) g	黄铜(Brass) g
TL205A-0900	0.9	400	1200	1200
TL205A-1400	1.4	400	1700	1700
TL205A-1800	1.8	400	2100	2100
TL205A-2700	2.7	900	3710	3710
TL205A-3600	3.6	900	4910	4910
TL205A-4500	4.5	900	5410	5410
TL205A-5400	5.4	900	6310	6310
TL205A-6300	6.3	900	7310	7310
TL205A-7200	7.2	900	8110	8110
TL205A-8100	8.1	900	8910	8910
TL205A-9000	9	900	10010	10010
TL205A-10000	10	900	10810	10810



TL205B 防爆塑柄八角锤

Hammer, Sledge



规格及主要技术参数

产品代号 Number	规格(H) kg	长度(L) mm	铍青铜(Be-Cu) g	铝青铜(Al-Cu) g
TL205B-0900	0.9	400	1200	1200
TL205B-1400	1.4	400	1700	1700
TL205B-1800	1.8	400	2100	2100
TL205B-2700	2.7	900	3710	3710
TL205B-3600	3.6	900	4910	4910
TL205B-4500	4.5	900	5410	5410
TL205B-5400	5.4	900	6310	6310
TL205B-6300	6.3	900	7310	7310
TL205B-7200	7.2	900	8110	8110
TL205B-8100	8.1	900	8910	8910
TL205B-9000	9	900	10010	10010
TL205B-10000	10	900	10810	10810

TL205C 铜塑柄八角锤

Copper Hammer, Sledge

产品代号 Number	规格(H) kg	长度(L) mm	紫铜(Copper) g	黄铜(Brass) g
TL205C-0900	0.9	400	1200	1200
TL205C-1400	1.4	400	1700	1700
TL205C-1800	1.8	400	2100	2100
TL205C-2700	2.7	900	3710	3710
TL205C-3600	3.6	900	4910	4910
TL205C-4500	4.5	900	5410	5410
TL205C-5400	5.4	900	6310	6310
TL205C-6300	6.3	900	7310	7310
TL205C-7200	7.2	900	8110	8110
TL205C-8100	8.1	900	8910	8910
TL205C-9000	9	900	10010	10010
TL205C-10000	10	900	10810	10810

TL205D 防爆倒装塑柄锤子

Sledge Hammer



规格及主要技术参数

产品代号 Number	规格(H) kg	长度(L) mm	铍青铜(Be-Cu) g	铝青铜(Al-Cu) g
TL205D-0900	0.9	400	1200	1200
TL205D-1400	1.4	400	1700	1700
TL205D-1800	1.8	400	2100	2100
TL205D-2700	2.7	900	3710	3710
TL205D-3600	3.6	900	4910	4910
TL205D-4500	4.5	900	5410	5410
TL205D-5400	5.4	900	6310	6310
TL205D-6300	6.3	900	7310	7310
TL205D-7200	7.2	900	8110	8110
TL205D-8100	8.1	900	8910	8910
TL205D-9000	9	900	10010	10010
TL205D-10000	10	900	10810	10810

TL205E 铜倒装塑柄锤子

Copper Sledge Hammer

产品代号 Number	规格(H) kg	长度(L) mm	紫铜(Copper) g	黄铜(Brass) g
TL205E-0900	0.9	400	1200	1200
TL205E-1400	1.4	400	1700	1700
TL205E-1800	1.8	400	2100	2100
TL205E-2700	2.7	900	3710	3710
TL205E-3600	3.6	900	4910	4910
TL205E-4500	4.5	900	5410	5410
TL205E-5400	5.4	900	6310	6310
TL205E-6300	6.3	900	7310	7310
TL205E-7200	7.2	900	8110	8110
TL205E-8100	8.1	900	8910	8910
TL205E-9000	9	900	10010	10010
TL205E-10000	10	900	10810	10810

TL206 防爆木柄英式平顶锤

Hammer, Club



规格及主要技术参数

产品代号 Number	规格(H) kg	长度(L) mm	铍青铜(Be-Cu) g	铝青铜(Al-Cu) g
TL206-0910	0.91	400	910	910
TL206-1820	1.82	400	1800	1800

TL206A 铜木柄英式平顶锤

Copper Hammer, Club

产品代号 Number	规格(H) kg	长度(L) mm	紫铜(Copper) g	黄铜(Brass) g
TL206A-0910	0.91	400	910	910
TL206A-1820	1.82	400	1800	1800



TL206B 防爆塑柄英式平顶锤

Hammer, Club



规格及主要技术参数

产品代号 Number	规格(H) kg	长度(L) mm	铍青铜(Be-Cu) g	铝青铜(Al-Cu) g
TL206B-0910	0.91	400	910	910
TL206B-1820	1.82	400	1800	1800

TL206C 铜塑柄英式平顶锤

Copper Hammer, Club

	规格(H) kg	长度(L) mm	紫铜(Copper) g	黄铜(Brass) g
TL206C-0910	0.91	400	910	910
TL206C-1820	1.82	400	1800	1800

TL207 防爆木柄圆鼓锤

Hammer, Mallet



规格及主要技术参数

产品代号 Number	规格(H) kg	长度(L) mm	铍青铜(Be-Cu) g	铝青铜(Al-Cu) g
TL207-0900	0.9	400	1200	1200
TL207-1820	1.82	400	2120	2120
TL207-2730	2.73	400	3030	3030

TL207A 铜木柄圆鼓锤

Copper Hammer, Mallet

产品代号 Number	规格(H) kg	长度(L) mm	紫铜(Copper) g	黄铜(Brass) g
TL207A-0900	0.9	400	1200	1200
TL207A-1820	1.82	400	2120	2120
TL207A-2730	2.73	400	3030	3030

TL207B 防爆塑柄圆鼓锤

Hammer, Mallet



规格及主要技术参数

产品代号 Number	规格(H) kg	长度(L) mm	铍青铜(Be-Cu) g	铝青铜(Al-Cu) g
TL207B-0900	0.9	400	1200	1200
TL207B-1820	1.82	400	2120	2120
TL207B-2730	2.73	400	3030	3030

TL207C 铜塑柄圆鼓锤

Copper Hammer, Mallet

产品代号 Number	规格(H) kg	长度(L) mm	紫铜(Copper) g	黄铜(Brass) g
TL207C-0900	0.9	400	1200	1200
TL207C-1820	1.82	400	2120	2120
TL207C-2730	2.73	400	3030	3030

TL207D 防爆尼龙锤

Nylon Hammer



规格及主要技术参数

产品代号 Number	规格(H) kg	长度(L) mm	尼龙(Nylon) g
TL207D-0800	800	340	800
TL207D-1000	1000	400	1000

TL208 防爆木柄检验锤

Hammer, Testing



规格及主要技术参数

产品代号 Number	规格(H) kg	长度(L) mm	铍青铜(Be-Cu) g	铝青铜(Al-Cu) g
TL208-0150	0.15	300	206	206
TL208-0250	0.25	335	345	345



TL208B 防爆塑柄检验锤

Hammer, Testing



规格及主要技术参数

产品代号 Number	规格(H) kg	长度(L) mm	铍青铜(Be-Cu) g	铝青铜(Al-Cu) g
TL208B-0150	0.15	300	206	206
TL208B-0250	0.25	335	345	345

TL209 防爆木柄扁尾检验锤

Hammer, Engineer ' s CROSS Pein



规格及主要技术参数

产品代号 Number	规格(H) kg	长度(L) mm	铍青铜(Be-Cu) g	铝青铜(Al-Cu) g
TL209-0500	0.5	400	650	650
TL209-0900	0.9	400	1100	1100

TL209A 防爆塑柄扁尾检验锤

Hammer, Engineer ' s CROSS Pein



规格及主要技术参数

产品代号 Number	规格(H) kg	长度(L) mm	铍青铜(Be-Cu) g	铝青铜(Al-Cu) g
TL209A-0500	0.5	400	650	650
TL209A-0900	0.9	400	1100	1100

TL210 防爆木柄双刃开口榔头

Hammer, Cutoff



规格及主要技术参数

产品代号 Number	规格(H) kg	长度(L) mm	铍青铜(Be-Cu) g	铝青铜(Al-Cu) g
TL210-0450	0.4	310	600	600
TL210-0600	0.6	340	800	800

TL210A 防爆塑柄双刃开口榔头

Hammer, Cutoff



规格及主要技术参数

产品代号 Number	规格(H) kg	长度(L) mm	铍青铜(Be-Cu) g	铝青铜(Al-Cu) g
TL210A-0450	0.4	310	600	600
TL210A-0600	0.6	340	800	800

TL211 防爆石工锤

Hammer, Stonemason



规格及主要技术参数

产品代号 Number	规格(H) kg	长度(L) mm	铍青铜(Be-Cu) g	铝青铜(Al-Cu) g
TL211-1000	1	400	1300	1300
TL211-1500	1.5	400	1800	1800
TL211-2000	2	400	2300	2300

TL211A 防爆石工锤 (木)

Hammer, Stonemason



规格及主要技术参数

产品代号 Number	规格(H) kg	长度(L) mm	铍青铜(Be-Cu) g	铝青铜(Al-Cu) g
TL211A-1000	1	400	1300	1300
TL211A-1500	1.5	400	1800	1800
TL211A-2000	2	400	2300	2300

TL212 防爆木柄嵌口榔头

Hammer, pein



规格及主要技术参数

产品代号 Number	规格(H) kg	长度(L) mm	铍青铜(Be-Cu) g	铝青铜(Al-Cu) g
TL212-0250	0.25	310	450	450
TL212-0300	0.3	310	550	550



TL212A 防爆塑柄嵌口榔头

Hammer,pein



规格及主要技术参数

产品代号 Number	规格(H) kg	长度(L) mm	铍青铜(Be-Cu) g	铝青铜(Al-Cu) g
TL212A-0250	0.25	310	450	450
TL212A-0300	0.3	310	550	550

TL212B 防爆木柄开孔锤

Durchtreiber Hammer



规格及主要技术参数

产品代号 Number	规格(H) kg	长度(L) mm	铍青铜(Be-Cu) g	铝青铜(Al-Cu) g
TL212B-08	0.8	340	1000	1000
TL212B-10	0.8	340	1000	1000
TL212B-12	1.2	380	1400	1400
TL212B-16	1.2	380	1400	1400

TL212C 防爆塑柄开孔锤

Durchtreiber Hammer



规格及主要技术参数

产品代号 Number	规格(H) kg	长度(L) mm	铍青铜(Be-Cu) g	铝青铜(Al-Cu) g
TL212C-08	0.8	340	1000	1000
TL212C-10	0.8	340	1000	1000
TL212C-12	1.2	380	1400	1400
TL212C-16	1.2	380	1400	1400

TL212D 防爆安全环

Sicherungsring for Hammer



规格及主要技术参数

产品代号 Number	规格(H) kg	长度(L) mm	铍青铜(Be-Cu) g	铝青铜(Al-Cu) g
TL212D-0102	2	300	120	120
TL212D-0206	2-6	300	140	140

TL213 防爆双刃斧

Aex



规格及主要技术参数

产品代号 Number	规格(H) kg	长度(L) mm	铍青铜(Be-Cu) g	铝青铜(Al-Cu) g
TL213-0800	0.8	340	1000	1000
TL213-1000	1	340	1200	1200

TL213A 防爆板斧

Aex



规格及主要技术参数

产品代号 Number	规格(H) kg	长度(L) mm	铍青铜(Be-Cu) g	铝青铜(Al-Cu) g
TL213A-0750	2	750	2700	2450

TL214 防爆安全斧

Aex Fireman



规格及主要技术参数

产品代号 Number	规格(H) kg	长度(L) mm	铍青铜(Be-Cu) g	铝青铜(Al-Cu) g
TL214-1000	1	340	1250	1250
TL214-1500	1.5	340	1750	1750
TL214-2000	2	340	2250	2250

TL215 防爆铜顶斧

Aex,Copper Inset



规格及主要技术参数

产品代号 Number	规格(H) kg	长度(L) mm	紫铜(Copper) g	黄铜(Brass) g
TL215-0800	0.8	340	1000	1000
TL215-1000	1	340	1200	1200
TL215-1250	1.25	340	1450	1450

TIANLONG 天龙防爆工具
高精品质 全国领先地位



防爆旋具系列

专业制造商

TIANLONG

TIANLONG



TL216 防爆十字螺丝刀

Phillips Screwdriver



规格及主要技术参数

产品代号 Number	规格(S) mm	长度(L) mm	铍青铜(Be-Cu) g	铝青铜(Al-Cu) g
TL216-0050	50*3	50	35	32
TL216-0075	75*4	75	70	63
TL216-0100	100*5	100	75	70
TL216-0125	125*6	125	100	95
TL216-0150	150*7	150	110	105
TL216-0200	200*8	200	165	155
TL216-0250	250*9	250	185	170
TL216-0300	300*9	300	245	230
TL216-0350	350*10	350	270	255
TL216-0400	400*12	400	295	280
TL216-0450	450*13	450	320	300

TL217 防爆一字螺丝刀

Slotted Screwdriver



规格及主要技术参数

产品代号 Number	规格(S) mm	长度(L) mm	铍青铜(Be-Cu) g	铝青铜(Al-Cu) g
TL217-0050	50*3	50	35	33
TL217-0075	75*4	75	45	42
TL217-0100	100*5	100	75	70
TL217-0125	125*6	125	100	95
TL217-0150	150*7	150	125	120
TL217-0200	200*8	200	165	155
TL217-0250	250*9	250	185	175
TL217-0300	300*9	300	245	230
TL217-0350	350*10	350	290	275
TL217-0400	400*12	400	320	300
TL217-0450	450*13	450	450	430

TL218 防爆S型十字螺丝刀

Phillips Offset Screwdriver



规格及主要技术参数

产品代号 Number	规格(S) mm	长度(L) mm	铍青铜(Be-Cu) g	铝青铜(Al-Cu) g
TL218-0120	120	120	50	45
TL218-0140	140	140	90	83

TL219 防爆S型一字螺丝刀

Slotted Offset Screwdriver



规格及主要技术参数

产品代号 Number	规格(S) mm	长度(L) mm	铍青铜(Be-Cu) g	铝青铜(Al-Cu) g
TL219-0072	6*72	72	25	23
TL219-0125	8*125	125	55	50

TL220 防爆夹柄螺丝刀

Screwdriver



规格及主要技术参数

产品代号 Number	规格(S) mm	长度(L) mm	铍青铜(Be-Cu) g	铝青铜(Al-Cu) g
TL220-0100	8*100	100	135	125
TL220-0160	10*160	160	305	275

TL221 防爆穿心螺丝刀

Slotted Screwdriver



规格及主要技术参数

产品代号 Number	规格(S) mm	长度(L) mm	铍青铜(Be-Cu) g	铝青铜(Al-Cu) g
TL221-0100	100*5	100	71	65
TL221-0150	150*7	150	115	105
TL221-0200	200*8	200	197	180
TL221-0250	250*9	250	221	202
TL221-0300	300*10	300	304	278



TL222 防爆电工螺丝刀

Electrician Screwdriver



规格及主要技术参数

产品代号 Number	规格(S) mm	长度(L) mm	铍青铜(Be-Cu) g	铝青铜(Al-Cu) g
TL222-0100	5*100	100	75	70
TL222-0150	7*150	150	125	120
TL222-0200	8*200	200	165	155

TL223 防爆米字螺丝刀

Pozidriv Screwdriver



规格及主要技术参数

产品代号 Number	规格(S) mm	长度(L) mm	铍青铜(Be-Cu) g	铝青铜(Al-Cu) g
TL223-0050	50	50	35	33
TL223-0075	75	75	45	42
TL223-0100	100	100	85	80
TL223-0150	150	150	145	135
TL223-0200	200	200	230	210

TL224 防爆星型螺丝刀

TOrx Screwdriver



规格及主要技术参数

产品代号 Number	规格(S) mm	长度(L) mm	铍青铜(Be-Cu) g	铝青铜(Al-Cu) g
TL224-0075	T10*75	75	70	63
TL224-1075	T15*75	75	70	63
TL224-0100	T20*100	100	100	95
TL224-0125	T25*125	125	105	100
TL224-0150	T30*150	150	110	100
TL224-0200	T40*200	200	165	155
TL224-0250	T45*250	250	185	175

TL224A 防爆螺丝刀组合

Screwdriver Set



规格及主要技术参数

产品代号 Number	规格(S) mm	铍青铜(Be-Cu) g	铝青铜(Al-Cu) g
TL224A-04	3*75,5*100, 6*150,8*150	315	272
TL224A-05	PH1,PH2,PH3,PH4	315	272
TL224A-06	PH1,PH2,5*100, 6*100,6*150,8*150	515	444
TL224A-10	5*100,6*100,5*150, 6*150,8*150,PH1, PH2,PH3,PH4	1200	1035

TL225 防爆锥子

Marking Tool



规格及主要技术参数

产品代号 Number	规格(S) mm	长度(L) mm	铍青铜(Be-Cu) g	铝青铜(Al-Cu) g
TL225-0185	4*185	185	50	45
TL225-0200	5*200	200	100	90

TIANLONG 天龙防爆工具
高精品质 全国领先品牌



防爆撬凿系列

专业制造商

TIANLONG

TIANLONG



TL226 防爆钎子

Punch, Machinists



规格及主要技术参数

产品代号 Number	规格(S) mm	长度(L) mm	铍青铜(Be-Cu) g	铝青铜(Al-Cu) g
TL226-2240	22*400	400	1360	1173
TL226-2550	25*500	500	2207	1903
TL226-2560	25*600	600	2649	2284
TL226-2880	28*800	800	4431	3820
TL226-2810	28*1000	1000	5538	47756
TL226-3010	30*1000	1000	6360	5482
TL226-3012	30*1200	1200	7620	6569
TL226-3214	32*1400	1400	10128	8732

TL227 防爆六角钎子

Knockout Bar Hexagon



规格及主要技术参数

产品代号 Number	规格(S) mm	长度(L) mm	铍青铜(Be-Cu) g	铝青铜(Al-Cu) g
TL227-2040	20*400	400	1360	1173
TL227-2450	24*500	500	2207	1903
TL227-2460	24*600	600	2649	2284
TL227-2780	27*800	800	4431	3820
TL227-2710	27*1000	1000	5538	47756
TL227-3010	30*1000	1000	6360	5482
TL227-3012	30*1200	1200	7620	6569
TL227-3212	32*1200	1200	7620	6569
TL227-3214	32*1400	1400	10128	8732

TL228 防爆扁铲

Chisel Flat



规格及主要技术参数

产品代号 Number	规格(S) mm	长度(L) mm	铍青铜(Be-Cu) g	铝青铜(Al-Cu) g
TL228-0170	14*170	170	231	210
TL228-0180	16*180	180	295	271
TL228-0200	18*200	200	382	342
TL228-200	20*200	200	473	430
TL228-0220	22*220	220	658	582
TL228-0250	24*250	250	822	751
TL228-0300	25*300	300	1302	1002
TL228-0400	27*400	400	1702	1430

TL229 防爆六角扁铲

Chisel Hex/6 Point



规格及主要技术参数

产品代号 Number	规格(S) mm	长度(L) mm	铍青铜(Be-Cu) g	铝青铜(Al-Cu) g
TL229-0170	14*170	170	251	231
TL229-0180	16*180	180	300	256
TL229-0200	17*200	200	550	480
TL229-200	19*200	200	670	582
TL229-0220	22*220	220	695	590
TL229-0250	22*250	250	750	670
TL229-0300	24*300	300	1204	1090
TL229-0400	25*400	400	1605	1450
TL229-0500	27*500	500	2730	2481

TL230 防爆平尖铲扁铲

Chisel, Cross Cutting



规格及主要技术参数

产品代号 Number	规格(S) mm	长度(L) mm	铍青铜(Be-Cu) g	铝青铜(Al-Cu) g
TL230-0140	4*4*140	140	280	255
TL230-0200	4*4*200	200	480	435
TL230-0300	5*5*300	300	840	760

TL230A 防爆横断凿子

Cross Cut Chisel



规格及主要技术参数

产品代号 Number	规格(S) mm	长度(L) mm	铍青铜(Be-Cu) g	铝青铜(Al-Cu) g
TL230A-0150	8	150	290	250
TL230A-0200	8	200	395	340
TL230A-0250	8	250	557	480
TL230A-0300	10	300	742	640



TL231 防爆平口扁铲

Chisel, Flat



规格及主要技术参数

产品代号 Number	规格(S) mm	长度(L) mm	铍青铜(Be-Cu) g	铝青铜(Al-Cu) g
TL231-0150	22*150	150	235	205
TL231-0200	22*200	200	320	280
TL231-0250	24*250	250	490	440
TL231-0300	25*300	300	770	700
TL231-0400	27*400	400	1220	1100

TL231A 防爆开缝扁铲

Slitting Chisel



规格及主要技术参数

产品代号 Number	规格(S) mm	长度(L) mm	铍青铜(Be-Cu) g	铝青铜(Al-Cu) g
TL231A-0200	200	200	418	360
TL231A-0250	250	250	534	460
TL231A-0300	300	300	640	550

TL231B 防爆水泥弯铲

Caulking Tool



规格及主要技术参数

产品代号 Number	规格(S) mm	长度(L) mm	铍青铜(Be-Cu) g	铝青铜(Al-Cu) g
TL231B-0150	150	150	430	370
TL231B-0160	160	160	476	410
TL231B-0180	180	180	453	390
TL231B-0200	200	200	604	520
TL231B-0200	200	200	488	420
TL231B-0220	220	220	580	500
TL231B-0220	220	220	604	520
TL231B-0220	220	220	604	520
TL231B-0250	250	250	609	525
TL231B-0250	250	250	627	540

TL232 防爆凿子

Punch, Machinists



规格及主要技术参数

产品代号 Number	规格(S) mm	长度(L) mm	铍青铜(Be-Cu) g	铝青铜(Al-Cu) g
TL232-180	14*180	180	200	180
TL232-0180	16*180	180	240	220
TL232-0200	18*200	200	270	250
TL232-0220	20*220	220	340	320
TL232-0250	22*250	250	410	370
TL232-0300	25*300	300	600	520

TL233 防爆六方凿子

Punch, Machinists



规格及主要技术参数

产品代号 Number	规格(S) mm	长度(L) mm	铍青铜(Be-Cu) g	铝青铜(Al-Cu) g
TL233-0180	16*180	180	326	282
TL233-0200	17*200	200	409	376
TL233-0220	19*220	220	562	485
TL233-0250	22*250	250	855	738
TL233-0300	24*300	300	1220	1052
TL233-0400	24*400	400	1628	1404
TL233-0500	27*500	500	2576	2221
TL233-0600	27*600	600	3090	2664

TL234 防爆圆冲子

Round Pierce Punch



规格及主要技术参数

产品代号 Number	规格(S) mm	长度(L) mm	铍青铜(Be-Cu) g	铝青铜(Al-Cu) g
TL234-0511	5*11*150	150	105	95
TL234-0612	6*12*150	150	130	110
TL234-0712	7*12*160	160	150	135
TL234-0814	8*14*160	160	170	150
TL234-0914	9*14*180	180	255	230
TL234-1016	10*16*180	180	335	300
TL234-1116	11*16*180	180	425	367
TL234-1218	12*18*180	180	516	445



TL234A 防爆顶出冲子



Drift Cylindrical



规格及主要技术参数

产品代号 Number	规格(S) mm	长度(L) mm	铍青铜(Be-Cu) g	铝青铜(Al-Cu) g
TL234A-03	3	110	20	15
TL234A-04	4	110	57	50
TL234A-06	6	115	105	95
TL234A-08	8	120	130	115
TL234A-10	10	145	200	180
TL234A-12	12	160	280	260
TL234A-14	14	180	410	380
TL234A-16	16	200	640	600
TL234A-18	18	225	1070	960
TL234A-20	20	225	1230	1110

TL234B 防爆六角冲子



Chisel, Diamond Point



规格及主要技术参数

产品代号 Number	规格(S) mm	长度(L) mm	铍青铜(Be-Cu) g	铝青铜(Al-Cu) g
TL234B-05	5	150	235	215
TL234B-08	8	150	285	255
TL234B-10	10	150	345	315

TL234C 防爆圆筒状圆头冲子



Drift pin, Barrel straight



规格及主要技术参数

产品代号 Number	规格(S) mm	长度(L) mm	铍青铜(Be-Cu) g	铝青铜(Al-Cu) g
TL23C-0811	8*11*150	150	125	118
TL23C-1013	10*13*150	150	155	140
TL23C-1215	12*15*150	150	215	190
TL23C-1418	14*18*200	200	420	380
TL23C-1721	17*21*200	200	570	540
TL23C-1822	18*22*250	250	600	560
TL23C-2125	21*25*250	250	950	885
TL23C-2226	22*26*250	250	965	920
TL23C-2428	24*28*250	250	1270	1150
TL23C-2630	26*30*250	250	1390	1250
TL23C-2731	27*31*300	300	1900	1770

TL234D 防爆双头式冲子



Pin Punch



规格及主要技术参数

产品代号 Number	规格(S) mm	长度(L) mm	铍青铜(Be-Cu) g	铝青铜(Al-Cu) g
TL234D-0817	8*17*200	200	267	230
TL234D-0821	8*21*200	200	418	360
TL234D-1024	10*24*200	200	482	415
TL234D-1327	13*27*200	200	731	630
TL234D-1830	18*30*200	200	1021	880
TL234D-2232	22*32*200	200	1218	1050

TL235 防爆销式冲子



Drift Cylindrical



规格及主要技术参数

产品代号 Number	规格(S) mm	长度(L) mm	铍青铜(Be-Cu) g	铝青铜(Al-Cu) g
TL235-0410	4*10*140	140	96	87
TL235-0510	5*10*140	140	105	95
TL235-0612	6*12*150	150	130	110
TL235-0712	7*12*150	150	150	135
TL235-0814	8*14*160	160	170	150
TL235-0914	9*14*160	160	255	230
TL235-1016	10*16*180	180	335	300

TL236 防爆皮带冲子



Punching Pin



规格及主要技术参数

产品代号 Number	规格(S) mm	长度(L) mm	铍青铜(Be-Cu) g	铝青铜(Al-Cu) g
TL236-0310	3*100	100	150	130
TL236-0410	4*100	100	150	130
TL236-0511	5*110	110	180	155
TL236-0611	6*110	110	180	155
TL236-0712	7*120	120	210	180
TL236-0812	8*120	120	210	180
TL236-0913	9*130	130	260	225
TL236-1013	10*130	130	260	225
TL236-1113	11*130	130	260	225
TL236-1213	12*130	130	260	225



TL237 防爆顶尖

Punch Center



规格及主要技术参数

产品代号 Number	规格(S) mm	长度(L) mm	铍青铜(Be-Cu) g	铝青铜(Al-Cu) g
TL237-0100	16*100	100	145	125
TL237-0150	16*150	150	230	205
TL237-0200	18*200	200	392	340
TL237-0300	18*300	300	615	540

TL237A 防爆偏仪针

Marking Tool



规格及主要技术参数

产品代号 Number	规格(S) mm	长度(L) mm	铍青铜(Be-Cu) g	铝青铜(Al-Cu) g
TL237A-0187	4*32*187	187	15	10
TL237A-0252	4*42*252	252	20	15

TL238 防爆风机铲头

Chisel,Pneumatoc



规格及主要技术参数

产品代号 Number	规格(S) mm	长度(L) mm	铍青铜(Be-Cu) g	铝青铜(Al-Cu) g
TL238-0125	10*12*125	125	117	102
TL238-0175	10*12*175	175	168	143
TL238-0275	10*12*275	275	256	230

TL239 防爆风机铲头

Chisel,Pneumatoc



规格及主要技术参数

产品代号 Number	规格(S) mm	长度(L) mm	铍青铜(Be-Cu) g	铝青铜(Al-Cu) g
TL239-0125	10*20*125	125	160	140
TL239-0175	10*20*175	175	210	182
TL239-0275	10*20*275	275	320	295

TL240 防爆风机铲头

Chisel,Pneumatoc



规格及主要技术参数

产品代号 Number	规格(S) mm	长度(L) mm	铍青铜(Be-Cu) g	铝青铜(Al-Cu) g
TL240-0125	10*20*125	125	162	142
TL240-0175	10*20*275	175	213	183
TL240-0275	10*20*275	275	320	276

TL241 防爆风机铲头

Chisel,Pneumatoc



规格及主要技术参数

产品代号 Number	规格(S) mm	长度(L) mm	铍青铜(Be-Cu) g	铝青铜(Al-Cu) g
TL241-0125	10*20*125	125	152	117
TL241-0175	10*20*175	175	190	122
TL241-0275	10*20*275	275	270	233

TL242 防爆风机铲头

Chisel,Pneumatoc



规格及主要技术参数

产品代号 Number	规格(S) mm	长度(L) mm	铍青铜(Be-Cu) g	铝青铜(Al-Cu) g
TL242-0125	10*20*125	125	127	112
TL242-0175	10*20*175	175	178	153
TL242-0275	10*20*275	275	285	246

TL242A 防爆气动冲子

Chisel,Pneumatic Bull Point



规格及主要技术参数

产品代号 Number	规格(S) mm	长度(L) mm	铍青铜(Be-Cu) g	铝青铜(Al-Cu) g
TL242A-0500	28*500	500	2650	2400

TL243 防爆一头扁撬棍

Bar Pinch



规格及主要技术参数

产品代号 Number	规格(S) mm	长度(L) mm	铍青铜(Be-Cu) g	铝青铜(Al-Cu) g
TL243-0600	25*52*600	600	2435	2221
TL243-0800	28*52*800	800	4432	3821

TL244 防爆撬棍

Crow Bar



规格及主要技术参数

产品代号 Number	规格(S) mm	长度(L) mm	铍青铜(Be-Cu) g	铝青铜(Al-Cu) g
TL244-1840	18*400	400	916	790
TL244-2050	20*500	500	1295	1117
TL244-2250	22*500	500	1710	1475
TL244-2260	22*600	600	2052	1769
TL244-2560	25*600	600	2650	2285
TL244-2580	25*800	800	3175	2737
TL244-2880	28*800	800	4432	3821
TL244-2810	28*1000	1000	4710	4061
TL244-2812	28*1200	1200	6647	5731
TL244-3010	30*1000	1000	5595	4824
TL244-3012	30*1200	1200	6970	6009
TL244-3015	30*1500	1500	8665	7488
TL244-3215	32*1500	1500	10852	9356

TL244A 防爆六角撬棍

Bar (Hex) Pinch



规格及主要技术参数

产品代号 Number	规格(S) mm	长度(L) mm	铍青铜(Be-Cu) g	铝青铜(Al-Cu) g
TL244A-1550	15*500	500	738	675
TL244A-1950	19*500	500	1150	1050
TL244A-2050	20*500	500	1295	1185
TL244A-2550	25*500	500	1975	1805
TL244A-3050	30*500	500	2925	2675
TL244A-2560	25*600	600	2380	2175
TL244A-3060	30*600	600	3450	3155
TL244A-2380	23*800	800	2290	2095
TL244A-2580	25*800	800	3175	2905
TL244A-3080	30*800	800	4490	4105
TL244A-3085	30*850	850	4870	4455
TL244A-2510	25*1000	1000	3985	3645
TL244A-2810	28*1000	1000	4710	4305
TL244A-3010	30*1000	1000	5595	5115
TL244A-2512	25*1200	1200	4795	5385
TL244A-3012	30*1200	1200	6970	6375
TL244A-3015	30*1500	1500	8665	7925

TL245 防爆尖撬棍

Crow Bar Prong

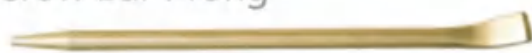

规格及主要技术参数

产品代号 Number	规格(S) mm	长度(L) mm	铍青铜(Be-Cu) g	铝青铜(Al-Cu) g
TL245-1840	18*400	400	916	790
TL245-2050	20*500	500	1413	1219
TL245-2260	22*600	600	2052	1769
TL245-2560	25*600	600	2650	2285
TL245-2580	25*800	800	3533	3046
TL245-2810	28*1000	1000	5539	4775

TL245A 防爆六角尖撬棍

Bar (Hex) Pinch



规格及主要技术参数

产品代号 Number	规格(S) mm	长度(L) mm	铍青铜(Be-Cu) g	铝青铜(Al-Cu) g
TL245A-1850	18*500	500	1200	1090
TL245A-2050	20*500	500	1450	1320
TL245A-2060	20*600	600	1750	1600
TL245A-2210	22*1000	1000	3500	3200
TL245A-2510	25*1000	1000	4500	4080
TL245A-2515	25*1500	1500	6750	6120
TL245A-3510	35*1000	1000	8800	8000

TL245B 防爆阶梯撬棍

Bar Crow



规格及主要技术参数

产品代号 Number	规格(S) mm	长度(L) mm	铍青铜(Be-Cu) g	铝青铜(Al-Cu) g
TL245B-0650	20*23*650	650	1855	1675

TL245C 防爆拨胎器

Type Lever



规格及主要技术参数

产品代号 Number	规格(S) mm	长度(L) mm	铍青铜(Be-Cu) g	铝青铜(Al-Cu) g
TL245C-0200	20*200	200	406	350
TL245C-0300	25*300	300	546	470
TL245C-0400	30*400	400	696	600
TL245C-0500	35*500	500	894	770
TL245C-0600	38*600	600	1044	900



TL246 防爆听针

Hearing Needle



规格及主要技术参数

产品代号 Number	规格(S) mm	长度(L) mm	铍青铜(Be-Cu) g	铝青铜(Al-Cu) g
TL246-0350	350	350	250	216
TL246-0450	450	450	360	310
TL246-0600	600	600	435	375
TL246-0750	750	750	585	505
TL246-1000	1000	1000	840	725
TL246-1200	1200	1200	1050	906

TL246A 防爆球头听针

Hearing Needle With Ball



规格及主要技术参数

产品代号 Number	规格(S) mm	长度(L) mm	铍青铜(Be-Cu) g	铝青铜(Al-Cu) g
TL246A-0350	350	350	250	216
TL246A-0450	450	450	360	310
TL246A-0600	600	600	435	375
TL246A-0750	750	750	585	505
TL246A-1000	1000	1000	840	725
TL246A-1200	1200	1200	1050	906

TL247 防爆平锉

File, Flat



规格及主要技术参数

产品代号 Number	规格(S) mm	长度(L) mm	铍青铜(Be-Cu) g
TL247-0200	200	200	160
TL247-0250	250	250	282
TL247-0300	300	300	455

TL248 防爆三角锉

File, Square



规格及主要技术参数

产品代号 Number	规格(S) mm	长度(L) mm	铍青铜(Be-Cu) g
TL248-0200	200	200	115
TL248-0250	250	250	125
TL248-0300	300	300	160

TL249 防爆圆锉

File, Round



规格及主要技术参数

产品代号 Number	规格(S) mm	长度(L) mm	铍青铜(Be-Cu) g
TL249-0200	200	200	91
TL249-0250	250	250	122
TL249-0300	300	300	180

TL250 防爆半圆锉

File, Half Round



规格及主要技术参数

产品代号 Number	规格(S) mm	长度(L) mm	铍青铜(Be-Cu) g
TL250-0200	200	200	190
TL250-0250	250	250	255
TL250-0300	300	300	375

TL251 防爆方锉

File, Square



规格及主要技术参数

产品代号 Number	规格(S) mm	长度(L) mm	铍青铜(Be-Cu) g
TL251-0200	200	200	130
TL251-0250	250	250	155
TL251-0300	300	300	202

TIANLONG 天龙防爆工具
高精品质 全国领先品牌



防爆刀锯系列

专业制造商

TIANLONG

TIANLONG



TL252 防爆布艺剪刀

Scissors



规格及主要技术参数

产品代号 Number	规格(S) mm	长度(L) mm	铍青铜(Be-Cu) g	铝青铜(Al-Cu) g
TL252-0215	1#-215	215	245	210

TL253 防爆工艺剪刀

Shears, Cutting



规格及主要技术参数

产品代号 Number	规格(S) mm	铍青铜(Be-Cu) g	铝青铜(Al-Cu) g
TL253-0185	185	150	130

TL254 防爆铁皮剪刀

Shears, Tin



规格及主要技术参数

产品代号 Number	规格(S) mm	铍青铜(Be-Cu) g	铝青铜(Al-Cu) g
TL254-0250	250	235	215
TL254-0300	300	900	823

TL254A 防爆铁皮剪刀

Shears, Tin



规格及主要技术参数

产品代号 Number	规格(S) mm	铍青铜(Be-Cu) g	铝青铜(Al-Cu) g
TL254A-0250	250	420	330
TL254A-0300	300	488	410

TL254B 防爆剪子

Tinner's Snip Plate Shear



规格及主要技术参数

产品代号 Number	长度(L) mm	铍青铜(Be-Cu) g	铝青铜(Al-Cu) g
TL254B-1002	280	500	450

TL254C 防爆园艺剪子

Hedge Shears



规格及主要技术参数

产品代号 Number	规格(S) mm	长度(L) mm	铍青铜(Be-Cu) g	铝青铜(Al-Cu) g
TL254C-1002	520	520	1620	1400

TL254D 防爆镰刀

Reaping Hook



规格及主要技术参数

产品代号 Number	规格(S) mm	长度(L) mm	铍青铜(Be-Cu) g	铝青铜(Al-Cu) g
TL254D-0360	360	360	930	800

TL255 防爆削皮刀

Knife Utility



规格及主要技术参数

产品代号 Number	规格(S) mm	长度(L) mm	铍青铜(Be-Cu) g	铝青铜(Al-Cu) g
TL255-0220	220	220	85	105
TL255-0250	250	250	95	125



TL255A 防爆木柄削皮刀

Knife Utility



规格及主要技术参数

产品代号 Number	规格(S) mm	长度(L) mm	铍青铜(Be-Cu) g	铝青铜(Al-Cu) g
TL255A-0220	220	220	85	105
TL255A-0250	250	250	95	125

TL256 防爆电工刀

Knife Electrician's



规格及主要技术参数

产品代号 Number	规格(S) mm	长度(L) mm	铍青铜(Be-Cu) g	铝青铜(Al-Cu) g
TL256-0220	120	120	210	185

TL257 防爆油漆桶刀

Opener Carbide Drum



规格及主要技术参数

产品代号 Number	规格(S) mm	长度(L) mm	铍青铜(Be-Cu) g	铝青铜(Al-Cu) g
TL257-0300	300	300	655	595

TL257A 防爆瓦刀

Tile



规格及主要技术参数

产品代号 Number	规格(S) mm	长度(L) mm	铍青铜(Be-Cu) g	铝青铜(Al-Cu) g
TL257A-0300	300	300	610	550

TL257B 防爆油漆桶刀

Opener Carbide Drum



规格及主要技术参数

产品代号 Number	规格(S) mm	长度(L) mm	铍青铜(Be-Cu) g	铝青铜(Al-Cu) g
TL257B-0300	300	300	870	750

TL257C 防爆开桶器

Drum Opener



规格及主要技术参数

产品代号 Number	规格(S) mm	长度(L) mm	铍青铜(Be-Cu) g	铝青铜(Al-Cu) g
TL257C-0460	460	460	3100	2800

TL257D 防爆提桶器

Wrench,Combination



规格及主要技术参数

产品代号 Number	规格(S) mm	长度(L) mm	铍青铜(Be-Cu) g	铝青铜(Al-Cu) g
TL257D-1060	1060	1060	4410	3800

TL258 防爆塑柄油灰刀

Putty Knife



规格及主要技术参数

产品代号 Number	规格(S) mm	长度(L) mm	铍青铜(Be-Cu) g	铝青铜(Al-Cu) g
TL258-4020	40*200	200	95	90
TL258-5020	50*200	200	105	115
TL258-7520	75*200	200	115	120
TL258-1020	100*200	200	125	165



TL258A 防爆木柄油灰刀

Putty Knife



规格及主要技术参数

产品代号 Number	规格(S) mm	长度(L) mm	铍青铜(Be-Cu) g	铝青铜(Al-Cu) g
TL258A-4020	40*200	200	95	90
TL258A-5020	50*200	200	105	115
TL258A-7520	75*200	200	115	120
TL258A-1020	100*200	200	125	165

TL258B 防爆地板刮刀

Wide Scraper, Stiff Blade



规格及主要技术参数

产品代号 Number	规格(S) mm	长度(L) mm	铍青铜(Be-Cu) g	铝青铜(Al-Cu) g
TL258B-0160	160	205	350	300

TL259 防爆塑柄圆弧抹刀

Spatula



规格及主要技术参数

产品代号 Number	规格(S) mm	长度(L) mm	铍青铜(Be-Cu) g	铝青铜(Al-Cu) g
TL259-0090	30*90	90	85	80
TL259-0105	50*105	105	115	110
TL259-0120	90*120	120	160	145

TL259A 防爆加长圆弧抹刀

Spatula Lengthen



规格及主要技术参数

产品代号 Number	规格(S) mm	长度(L) mm	铍青铜(Be-Cu) g	铝青铜(Al-Cu) g
TL259A-0250	250	350	168	145
TL259A-0350	350	490	320	275

TL260 防爆两头扁刮刀

Scraper



规格及主要技术参数

产品代号 Number	规格(S) mm	长度(L) mm	铍青铜(Be-Cu) g	铝青铜(Al-Cu) g
TL260-0300	50*300	300	555	507
TL260-0450	60*450	450	875	800
TL260-0600	70*600	600	1405	1290
TL260-0750	80*750	750	1540	1380

TL261 防爆刮刀

Scraper, Deck



规格及主要技术参数

产品代号 Number	规格(S) mm	长度(L) mm	铍青铜(Be-Cu) g	铝青铜(Al-Cu) g
TL261-0300	300	300	380	335
TL261-0350	350	350	555	507
TL261-0400	400	400	775	700
TL261-0450	450	450	875	800

TL262 防爆除锈刀

Scraper, Flat



规格及主要技术参数

产品代号 Number	规格(S) mm	长度(L) mm	铍青铜(Be-Cu) g	铝青铜(Al-Cu) g
TL262-0200	30*200	200	330	300
TL262-0300	30*300	300	480	440
TL262-0350	35*350	350	1020	910
TL262-0400	45*400	400	1520	1330

TL263 防爆方头除锈刀

Scraper, Hand Style



规格及主要技术参数

产品代号 Number	规格(S) mm	长度(L) mm	铍青铜(Be-Cu) g	铝青铜(Al-Cu) g
TL263-0480	95*95*480	480	600	540



TL263A 防爆三角刮刀

Scraper, Triangular



规格及主要技术参数

产品代号 Number	规格(S) mm	长度(L) mm	铍青铜(Be-Cu) g	铝青铜(Al-Cu) g
TL263A-0300	300	400	645	590

TL263B 防爆三角片刮刀

Scraper Plate



规格及主要技术参数

产品代号 Number	规格(S) mm	长度(L) mm	铍青铜(Be-Cu) g	铝青铜(Al-Cu) g
TL263B-0150	150	400	900	810

TL263C 防爆半月刮刀

Scraper, Halfmoon



规格及主要技术参数

产品代号 Number	规格(S) mm	长度(L) mm	铍青铜(Be-Cu) g	铝青铜(Al-Cu) g
TL263C-0100	100	320	260	235

TL264 防爆锯弓子

Hacksaw Franme



规格及主要技术参数

产品代号 Number	规格(S) mm	长度(L) mm	铍青铜(Be-Cu) g	铝青铜(Al-Cu) g
TL264-0500	300	500	650	590

TL264A 防爆锯弓子

Hacksaw Franme



规格及主要技术参数

产品代号 Number	规格(S) mm	长度(L) mm	铍青铜(Be-Cu) g	铝青铜(Al-Cu) g
TL264A-0500	300	500	650	590

TL265 防爆锯条

Hacksaw Blade



规格及主要技术参数

产品代号 Number	规格(S) mm	长度(L) mm	铍青铜(Be-Cu) g
TL265-0300	300	300	32

TL266 防爆鸡尾锯

Hand Saw



规格及主要技术参数

产品代号 Number	规格(S) mm	长度(L) mm	铍青铜(Be-Cu) g
	370	370	125

TL267 防爆手板锯

Hand Saw



规格及主要技术参数

产品代号 Number	规格(S) mm	长度(L) mm	铍青铜(Be-Cu) g
TL267-0450	450	450	555

TIANLONG 天龙防爆工具
高精品质 全国领先品牌



防爆刷子系列

专业制造商

TIANLONG

TIANLONG



TL268 防爆长柄圆头刷

Brush, Flat Back, Scratch



规格及主要技术参数

产品代号 Number	规格(S) mm	长度(L) mm	铝青铜(Al-Cu) g
TL268-0416	4*16	290	115

TL268A 防爆长柄圆头刷

Brush, Flat Back, Scratch



规格及主要技术参数

产品代号 Number	规格(S) mm	长度(L) mm	铝青铜(Al-Cu) g
TL268A-0419	4*19	350	150

TL269 防爆板刷

Brush



规格及主要技术参数

产品代号 Number	规格(S) mm	长度(L) mm	铝青铜(Al-Cu) g
TL269-0619	6*17	150	260

TL269A 防爆板刷

Brush



规格及主要技术参数

产品代号 Number	规格(S) mm	长度(L) mm	铝青铜(Al-Cu) g
TL269A-0619	6*17	200	360

TL270 防爆试管刷

Brush, Tube



规格及主要技术参数

产品代号 Number	规格(S) mm	长度(L) mm	铝青铜(Al-Cu) g
TL270-2010	20*100	320	100

TL271 防爆硬制板刷

Scrubbing Broom, Round Wire



规格及主要技术参数

产品代号 Number	规格(S) mm	长度(L) mm	铝青铜(Al-Cu) g
TL271-0617	6*19	200	500

TL272 防爆碗形刷

Cup Brush Crimped Wire



规格及主要技术参数

产品代号 Number	规格(S) mm	长度(L) mm	铝青铜(Al-Cu) g
TL272-0125	125	125	400

TL273 防爆碟型刷

Dish Brush Crimped Wire



规格及主要技术参数

产品代号 Number	规格(S) mm	长度(L) mm	铝青铜(Al-Cu) g
TL273-0125	125	125	350

TIANLONG 天龙防爆工具
高精品质 全国领先品牌



防爆锹铲系列

专业制造商

TIANLONG

TIANLONG



TL274 防爆方锹

Slovel, Square



规格及主要技术参数

产品代号 Number	规格(S) mm	长度(L) mm	铍青铜(Be-Cu) g	铝青铜(Al-Cu) g
TL274-0418	1#-418*215	1000	1800	1650
TL274-0350	3#-350*185	950	1400	1290

TL274C 防爆小方锹

Slovel, Square

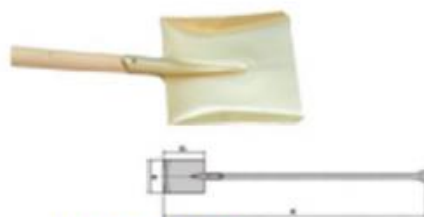

规格及主要技术参数

产品代号 Number	规格(S) mm	长度(L) mm	铍青铜(Be-Cu) g	铝青铜(Al-Cu) g
TL274C-0350	3#-350*185	540	1500	1200

TL274A 铝方锹

Slovel, Square Aluminum



规格及主要技术参数

产品代号 Number	规格(S) mm	长度(L) mm	铝(Aluminum) g
TL274A-0418	1#-418*215	1000	600
TL274A-0350	3#-350*185	950	500

TL274D 铝小方锹

Slovel, Square Aluminum



规格及主要技术参数

产品代号 Number	规格(S) mm	长度(L) mm	铝(Aluminum) g
TL274D-0350	3#-350*185	540	450

TL274B 不锈钢方锹

Slovel, Square Stainless Steel

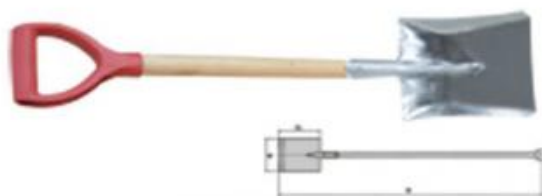

规格及主要技术参数

产品代号 Number	规格(S) mm	长度(L) mm	不锈钢(Stainless Steel) g
TL274B-0418	1#-418*215	1000	1650
TL274B-0350	3#-350*185	950	1290

TL274E 不锈钢小方锹

Slovel, Square Stainless Steel

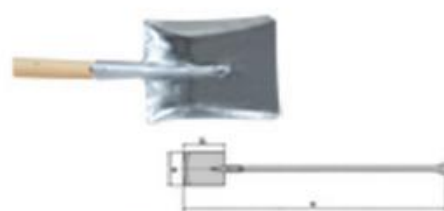

规格及主要技术参数

产品代号 Number	规格(S) mm	长度(L) mm	不锈钢(Stainless Steel) g
TL274E-0350	3#-350*185	540	1200



TL275 防爆尖锹

Slovel,Round Point



规格及主要技术参数

产品代号 Number	规格(S) mm	长度(L) mm	铍青铜(Be-Cu) g	铝青铜(Al-Cu) g
TL275-0420	2#-420*235	1000	1500	1400

TL276 防爆煤锹

Dust Pan



规格及主要技术参数

产品代号 Number	规格(S) mm	长度(L) mm	铍青铜(Be-Cu) g	铝青铜(Al-Cu) g
TL276-0510	2#-510*275	1200	2330	2130

TL275A 铝尖锹

Slovel,Round Point Aluminum

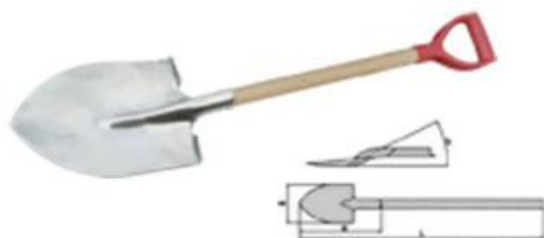

规格及主要技术参数

产品代号 Number	规格(S) mm	长度(L) mm	铝(Aluminum) g
TL275A-0420	2#-420*235	1000	500

TL276A 铝煤锹

Dust Pan Aluminum



规格及主要技术参数

产品代号 Number	规格(S) mm	长度(L) mm	铝(Aluminum) g
TL276A-0510	510*275	1200	1000

TL275B 不锈钢尖锹

Slovel,Round Point Stainless Steel

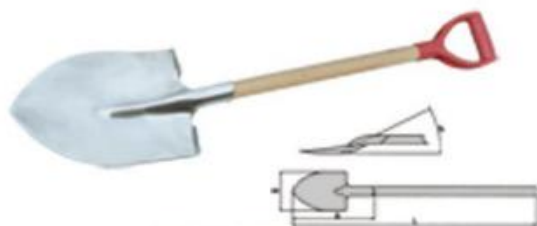

规格及主要技术参数

产品代号 Number	规格(S) mm	长度(L) mm	不锈钢(Stainless Steel) g
TL275B-0420	2#-420*235	1000	1400

TL276B 不锈钢煤锹

Dust Pan Stainless Steel



规格及主要技术参数

产品代号 Number	规格(S) mm	长度(L) mm	不锈钢(Stainless Steel) g
TL276B-0510	510*275	1200	2130



TL277 防爆两用锹

Folding Spade



规格及主要技术参数

产品代号 Number	规格(S) mm	长度(L) mm	铍青铜(Be-Cu) g	铝青铜(Al-Cu) g
TL277-0320	180*320	600	1500	1350

TL280 防爆镐头

Pick Railroad



规格及主要技术参数

产品代号 Number	规格(S) mm	长度(L) mm	铍青铜(Be-Cu) g	铝青铜(Al-Cu) g
TL280-0450	450	900	2320	2000
TL280-0520	520	900	2950	2500
TL280-0600	600	900	3480	3000

TL278 防爆多用锹

Use The Shovel



规格及主要技术参数

产品代号 Number	规格(S) mm	长度(L) mm	铍青铜(Be-Cu) g	铝青铜(Al-Cu) g
TL278-0320	180*320	600	1500	1350

TL280A 防爆双尖镐头

Pick Railroad



规格及主要技术参数

产品代号 Number	规格(S) mm	长度(L) mm	铍青铜(Be-Cu) g	铝青铜(Al-Cu) g
TL280A-0450	1#	900	2950	2800
TL280A-0520	2#	900	3385	3200
TL280A-0600	3#	900	4330	4000

TL279 防爆直锹

Edging Spade



规格及主要技术参数

产品代号 Number	规格(S) mm	长度(L) mm	铍青铜(Be-Cu) g	铝青铜(Al-Cu) g
TL279-0290	190*290	1350	3700	3480

TL280B 防爆锤子镐头

Miner's Pick



规格及主要技术参数

产品代号 Number	规格(S) mm	长度(L) mm	铍青铜(Be-Cu) g	铝青铜(Al-Cu) g
TL280B-0400	400	900	2550	2200



TL280C 防爆井盖勾子

Sewer lid Hook



规格及主要技术参数

产品代号 Number	规格(S) mm	长度(L) mm	铍青铜(Be-Cu) g	铝青铜(Al-Cu) g
TL280C-0500	500	500	890	770

TL280D 防爆节梯井盖勾子

Sewer lid Hook, Reinforced



规格及主要技术参数

产品代号 Number	规格(S) mm	长度(L) mm	铍青铜(Be-Cu) g	铝青铜(Al-Cu) g
TL280D-0700	700	700	1390	1200

TL281 防爆羊角起钉器

Bar, Wrecking



规格及主要技术参数

产品代号 Number	规格(S) mm	长度(L) mm	铍青铜(Be-Cu) g	铝青铜(Al-Cu) g
TL281-0250	13*250	250	280	250
TL281-0300	14*300	300	390	360

TL282 防爆勾型羊角起钉器

Bar, Wrecking



规格及主要技术参数

产品代号 Number	规格(S) mm	长度(L) mm	铍青铜(Be-Cu) g	铝青铜(Al-Cu) g
TL282-0350	350	350	750	680
TL282-0450	450	450	960	890
TL282-0600	600	600	1102	1002

TL282A 防爆六角起钉器

Bar, Wrecking Hex



规格及主要技术参数

产品代号 Number	规格(S) mm	长度(L) mm	铍青铜(Be-Cu) g	铝青铜(Al-Cu) g
TL282A-0460	16*460	460	890	800
TL282A-0760	22*760	760	3100	2800
TL282A-0920	22*920	920	3650	3300

TL282B 防爆起钉锤

Crate Opener

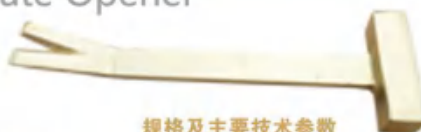

规格及主要技术参数

产品代号 Number	规格(S) mm	长度(L) mm	铍青铜(Be-Cu) g	铝青铜(Al-Cu) g
TL282B-0230	70	230	471	430

TL282C 防爆消防勾

Fire Hook



规格及主要技术参数

产品代号 Number	规格(S) mm	长度(L) mm	铍青铜(Be-Cu) g	铝青铜(Al-Cu) g
TL282C-0270	270	1200	1365	1300

TL282D 防爆消防勾

Fire Hook



规格及主要技术参数

产品代号 Number	规格(S) mm	长度(L) mm	铍青铜(Be-Cu) g	铝青铜(Al-Cu) g
TL282D-0380	380	1200	2100	1800



TL283 防爆除锈铲

Scraper



规格及主要技术参数

产品代号 Number	规格(S) mm	长度(L) mm	铍青铜(Be-Cu) g	铝青铜(Al-Cu) g
TL283-0055	55	550	550	520
TL283-0075	75	550	750	700
TL283-0100	100	550	850	800
TL283-0125	125	550	1300	1200

TL284 防爆弧形除锈铲

Scraper,Arched



规格及主要技术参数

产品代号 Number	规格(S) mm	长度(L) mm	铍青铜(Be-Cu) g	铝青铜(Al-Cu) g
TL284-0075	75	550	750	700
TL284-0100	100	550	850	800
TL284-0125	125	550	1300	1200

TL285 防爆长柄除锈铲

Scraper



规格及主要技术参数

产品代号 Number	规格(S) mm	长度(L) mm	铍青铜(Be-Cu) g	铝青铜(Al-Cu) g
TL285-0055	55	900	683	625
TL285-0750	75	900	720	640
TL285-0100	100	900	880	800

TL285A 防爆长柄除锈铲

Scraper



规格及主要技术参数

产品代号 Number	规格(S) mm	长度(L) mm	铍青铜(Be-Cu) g	铝青铜(Al-Cu) g
TL285A-0055	55	900	683	625
TL285A-0750	75	900	720	640
TL285A-0100	100	900	880	800

TL285B 防爆地板铲

Floor Scraper



规格及主要技术参数

产品代号 Number	规格(S) mm	长度(L) mm	铍青铜(Be-Cu) g	铝青铜(Al-Cu) g
TL285B-0150	150	600	840	720

TL286 防爆除锈铲

Scraper,Spray Booth



规格及主要技术参数

产品代号 Number	规格(S) mm	长度(L) mm	铍青铜(Be-Cu) g	铝青铜(Al-Cu) g
TL286-0235	75	235	392	358

TL286A 防爆刮铲

Deck Scraper



规格及主要技术参数

产品代号 Number	规格(B) mm	长度(L) mm	铍青铜(Be-Cu) g	铝青铜(Al-Cu) g
TL286A-0075	75	150	580	500
TL286A-0125	125	235	930	800

TL287 防爆铲式砖瓦锤

Scraper,Pick And Scaler



规格及主要技术参数

产品代号 Number	规格(S) mm	长度(L) mm	铍青铜(Be-Cu) g	铝青铜(Al-Cu) g
TL287-0450	75*450	450	1285	1155

TIANLONG 天龙防爆工具
高精品质 全国领先品牌



防爆其它系列

专业制造商

TIANLONG

TIANLONG



TL288 防爆手拉葫芦

Chain Hoist



规格及主要技术参数

产品代号 Number	规格(T) mm	长度(L) mm	铍青铜(Be-Cu) g	铝青铜(Al-Cu) g
TL288-01	1	3	15576	13600
TL288-02	2	3	25526	22000
TL288-03	3	3	27376	23600
TL288-05	5	3	41760	36000

TL289 防爆手拉单轨小车

Trolley For Chain Hoist



规格及主要技术参数

产品代号 Number	规格(T) mm	长度(L) mm	铍青铜(Be-Cu) g	铝青铜(Al-Cu) g
TL289-01	1	3	23200	20000
TL289-02	2	3	22900	26000
TL289-03	3	3	31900	27500
TL289-05	5	3	39440	34000

TL288A 不锈钢手拉葫芦

Chain Hoist Stainless Steel



规格及主要技术参数

产品代号 Number	规格(T) mm	长度(L) mm	不锈钢(Stainless Steel) g
TL288A-01	1	3	13600
TL288A-02	2	3	22000
TL288A-03	3	3	23600
TL288A-05	5	3	36000

TL289A 不锈钢手拉单轨小车

Trolley For Chain Hoist Stainless Steel

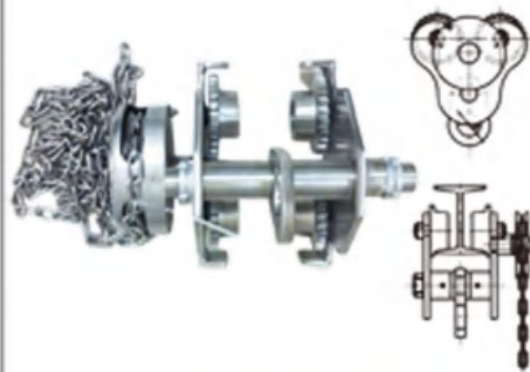

规格及主要技术参数

产品代号 Number	规格(T) mm	长度(L) mm	不锈钢(Stainless Steel) g
TL289A-01	1	3	20000
TL289A-02	2	3	26000
TL289A-03	3	3	27500
TL289A-05	5	3	34000



TL290 防爆手推单轨小车

Trolley For Chain Hoist



规格及主要技术参数

产品代号 Number	规格(T) mm	长度(L) mm	铍青铜(Be-Cu) g	铝青铜(Al-Cu) g
TL290-01	1	3	19140	16500
TL290-02	2	3	25520	22000
TL290-03	3	3	27260	23500
TL290-05	5	3	34800	30000

TL291 防爆千斤顶

Screw Jack



规格及主要技术参数

产品代号 Number	规格(T) mm	MN.H mm	Lifting mm
TL291-03	3	220	105
TL291-05	5	245	125
TL291-10	10	280	150
TL291-16	16	320	180

TL292 防爆管子割刀

Pipe, Cutter



规格及主要技术参数

产品代号 Number	规格(T) mm	长度(L) mm	铍青铜(Be-Cu) g	铝青铜(Al-Cu) g
TL292-01	1	50	2210	2010
TL292-02	2	75	4070	3700

TL293 防爆刨刀

Plane's Blade

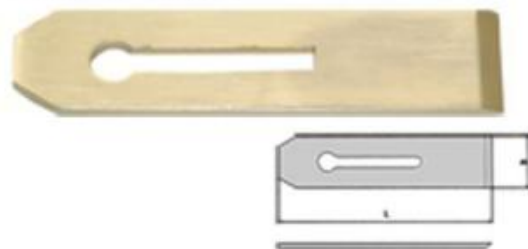

规格及主要技术参数

产品代号 Number	规格(T) mm	长度(L) mm	铍青铜(Be-Cu) g	铝青铜(Al-Cu) g
TL293-0043	43	175	146	130

TL294 防爆线锤

Hammer, Plumb

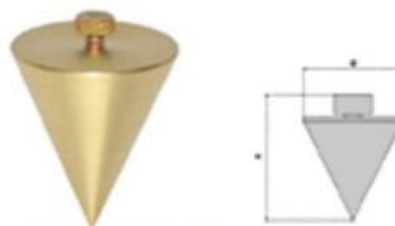

规格及主要技术参数

产品代号 Number	规格(T) mm	长度(L) mm	铍青铜(Be-Cu) g	铝青铜(Al-Cu) g
TL294-59	50 x 59	59	275	247



TL295 防爆砧子

Anvil Block



规格及主要技术参数

产品代号 Number	规格(T) mm	长度(L) mm	铍青铜(Be-Cu) g	铝青铜(Al-Cu) g
TL295-3000	3000	90	3000	3000
TL295-5000	5000	110	5000	5000
TL295-16000	16000	160	16000	16000

TL296 防爆三抓拉马

3 Leg Gear Puller



规格及主要技术参数

产品代号 Number	规格(L) mm	铍青铜(Be-Cu) g	铝青铜(Al-Cu) g
TL296-0100	100	4360	3960
TL296-0150	150	5230	4750
TL296-0200	200	5610	5100
TL296-0250	250	8500	7800
TL296-0300	300	12350	11230

TL297 防爆两抓拉马

2 Leg Gear Puller

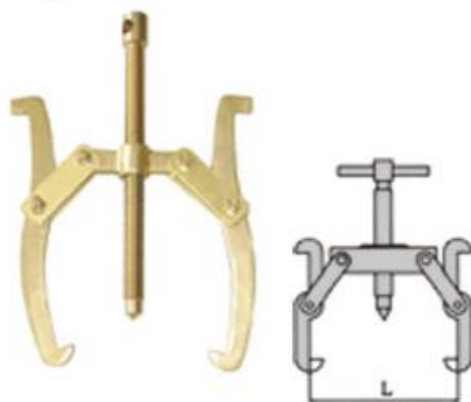

规格及主要技术参数

产品代号 Number	规格(L) mm	铍青铜(Be-Cu) g	铝青铜(Al-Cu) g
TL297-0100	100	2765	2500
TL297-0150	150	3450	3120
TL297-0200	200	5130	4640
TL297-0250	250	7100	6550
TL297-0300	300	10560	9545

TL298 防爆G型夹

Clamp

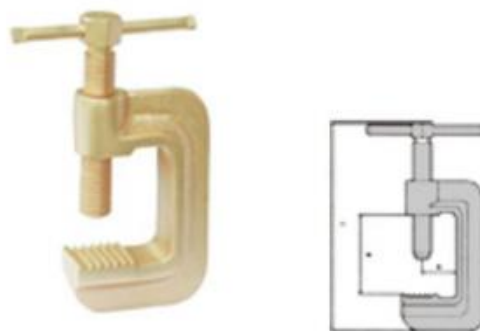

规格及主要技术参数

产品代号 Number	规格(K) mm	长度(L) mm	铍青铜(Be-Cu) g	铝青铜(Al-Cu) g
TL298-060	60	210	1200	1080
TL298-080	80	250	1400	1270
TL298-0100	100	290	1610	1460
TL298-0150	150	340	2155	1970



TL299 防爆G型夹

Clamp



规格及主要技术参数

产品代号 Number	规格(K) mm	长度(L) mm	铍青铜(Be-Cu) g	铝青铜(Al-Cu) g
TL299-019	19	76	200	180
TL299-0115	115	290	5600	1000
TL299-0165	165	370	11000	10000

TL299A 防爆卡兰

Screw Jack



规格及主要技术参数

产品代号 Number	规格(K) mm	宽度B mm	铍青铜(Be-Cu) g	铝青铜(Al-Cu) g
TL299A-0120	400	120	2395	2200

TL299B 防爆加长卡兰

Screw Jack Lengthen



规格及主要技术参数

产品代号 Number	规格(K) mm	宽度B mm	铍青铜(Be-Cu) g	铝青铜(Al-Cu) g
TL299B-0250	250	480	4300	3700

TL300 防爆法兰支开器

Flange Prop



规格及主要技术参数

产品代号 Number	规格(S) mm	铍青铜(Be-Cu) g	铝青铜(Al-Cu) g
TL300-1624	FZM16-24	5200	4600
TL300-2736	FZM27-36	6500	5800

TL300A 防爆法兰开启刀

Round Gasket Knife



规格及主要技术参数

产品代号 Number	规格(S) mm	铍青铜(Be-Cu) g	铝青铜(Al-Cu) g
TL300A-0400	30*400	1390	1200
TL300A-0800	40*800	2320	2000

TL300B 防爆尖头法兰开启刀

Straight Gasket Knife With Manfrel



规格及主要技术参数

产品代号 Number	规格(S) mm	宽度B mm	铍青铜(Be-Cu) g	铝青铜(Al-Cu) g
TL300B-0400	220	25	350	300

TL301 防爆台虎钳

Parallel Vice



规格及主要技术参数

产品代号 Number	规格(K) mm	铍青铜(Be-Cu) g	铝青铜(Al-Cu) g
TL301-0090	90	8150	7400
TL301-0125	125	19550	16800
TL301-0150	150	30000	26500
TL301-0170	170	30300	27400



TL302 防爆手摇泵

Manual Portable Oil Pump



规格及主要技术参数

产品代号 Number	规格(L) mm	长度(L) mm	铍青铜(Be-Cu) g	铝青铜(Al-Cu) g
TL302-1000	25 × 1350	1350	6000	5700

TL303 防爆卸扣

Shackle

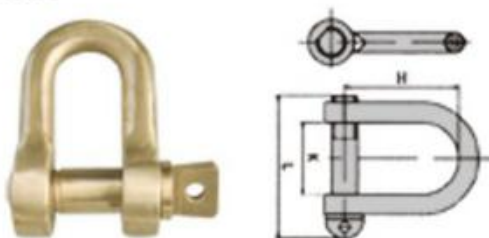

规格及主要技术参数

产品代号 Number	规格(K) mm	铍青铜(Be-Cu) g	铝青铜(Al-Cu) g
TL303-1010	S-DW-1-3/8"	85	74
TL303-2013	S-DW-2-1/2"	105	90
TL303-3016	S-DW-3-5/8"	120	105
TL303-4519	S-DW-4.5-3/4"	135	116
TL303-6522	S-DW-6.5-7/8"	185	160
TL303-8525	S-DW-8.5-1"	210	180
TL303-1029	S-DW-10-1-1/8"	320	275

TL304 防爆工具车

Explosion-proof Tool



规格及主要技术参数

产品代号 Number	规格 mm	长度(L) mm	铍青铜(Be-Cu) g	铝青铜(Al-Cu) g
TL304-0900	425 × 625 × 900	900	35000	32000

TL304A 防爆液压铲车

Hydraulic Pallet Truck



规格及主要技术参数

产品代号 Number	规格(T)	长度(L) mm	铍青铜(Be-Cu) g	铝青铜(Al-Cu) g
TL304A-02	2	1200	153000	132000

TL305 防爆弯管器

Explosion-proof Tool



规格及主要技术参数

产品代号 Number	规格(S) mm	长度(L) mm	铍青铜(Be-Cu) g	铝青铜(Al-Cu) g
TL305-0250	250	250	950	820

TL306 防爆黄油枪

Lubricating Screw



规格及主要技术参数

产品代号 Number	规格(S) mm	长度(L) mm	铍青铜(Be-Cu) g	铝青铜(Al-Cu) g
TL306-0400	400	400	1200	1150



TL307 防爆油吸子

Oil Header



规格及主要技术参数

产品代号 Number	规格(S) mm	长度(L) mm	铍青铜(Be-Cu) g	铝青铜(Al-Cu) g
TL307-1100	1100	1100	2395	2050

TL308 防爆簸箕

Dustpan



规格及主要技术参数

产品代号 Number	规格(S) mm	长度(L) mm	铍青铜(Be-Cu) g	铝青铜(Al-Cu) g
TL308-1020	100 × 200	200	335	300
TL308-1922	190 × 225	225	630	540

TL308A 铝簸箕

Aluminum Dustpan



规格及主要技术参数

产品代号 Number	规格(S) mm	长度(L) mm	铝(Aluminum) g
TL308A-1020	100 × 200	200	210
TL308A-1922	190 × 225	225	260

TL309 防爆料铲

Scoop, Sugar



规格及主要技术参数

产品代号 Number	规格(B) mm	长度(L) mm	铍青铜(Be-Cu) g	铝青铜(Al-Cu) g
TL309-0130	75*130	130	200	170
TL309-0200	120*200	200	500	440
TL309-0240	140*240	240	645	520

TL309A 铝料铲

Aluminum Scoop, Sugar



规格及主要技术参数

产品代号 Number	规格(S) mm	长度(L) mm	铝(Aluminum) g
TL309A-0130	75*130	130	65
TL309A-0200	120*200	200	105
TL309A-0240	140*240	240	210

TL310 防爆尖头抹子

Mason's Float



规格及主要技术参数

产品代号 Number	规格(B) mm	长度(L) mm	铍青铜(Be-Cu) g	铝青铜(Al-Cu) g
TL310-200	75	200	420	340



TL310A 防爆方头抹子

Mason's Float



规格及主要技术参数

产品代号 Number	规格(B) mm	长度(L) mm	铍青铜(Be-Cu) g	铝青铜(Al-Cu) g
TL310A-200	75	200	420	340

TL310B 防爆大铲

Mason's Float



规格及主要技术参数

产品代号 Number	规格(B) mm	长度(L) mm	铍青铜(Be-Cu) g	铝青铜(Al-Cu) g
TL310B-130	130	350	440	360

TL310C 防爆水泥铲

Mason's Float



规格及主要技术参数

产品代号 Number	规格(B) mm	长度(L) mm	铍青铜(Be-Cu) g	铝青铜(Al-Cu) g
TL310C-180	90	180	210	180

TL311 防爆锄头

Hoe



规格及主要技术参数

产品代号 Number	规格(B) mm	长度(L) mm	铍青铜(Be-Cu) g	铝青铜(Al-Cu) g
TL311-0200	200	900	1780	1600

TL311A 防爆锄头

Hoe



规格及主要技术参数

产品代号 Number	规格(S) mm	长度(L) mm	铍青铜(Be-Cu) g	铝青铜(Al-Cu) g
TL311A-120	120	900	2650	2300

TL312 防爆油提子

Oil Dipper



规格及主要技术参数

产品代号 Number	规格(S) mm	长度(L) mm	铍青铜(Be-Cu) g	铝青铜(Al-Cu) g
TL312-085	85	350	190	165

TL313 防爆耙子

Cleaning Rust Rack



规格及主要技术参数

产品代号 Number	规格(S) mm	长度(L) mm	铍青铜(Be-Cu) g	铝青铜(Al-Cu) g
TL313-0400	100*400	1200	1050	950

TL314 防爆耙子

Rake



规格及主要技术参数

产品代号 Number	规格(S) mm	长度(L) mm	铍青铜(Be-Cu) g	铝青铜(Al-Cu) g
TL314-0400	80*160	1000	670	600



TL314A 防爆四齿叉子

Manure fork

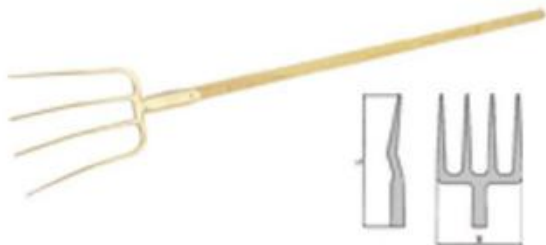

规格及主要技术参数

产品代号 Number	规格(T) mm	长度(L) mm	铍青铜(Be-Cu) g	铝青铜(Al-Cu) g
TL314A-0230	230*330	1400	1950	1640

TL314B 防爆四齿叉子

Spade fork

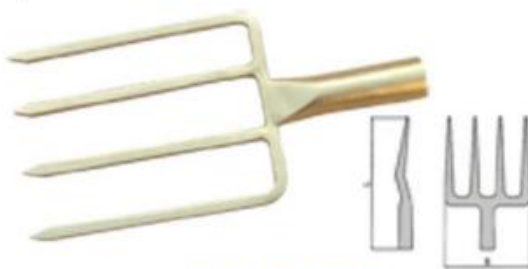

规格及主要技术参数

产品代号 Number	规格(T) mm	长度(L) mm	铍青铜(Be-Cu) g	铝青铜(Al-Cu) g
TL314B-0180	180*290	1000	1470	1270

TL314C 防爆三齿叉子

Hay fork



规格及主要技术参数

产品代号 Number	规格(T) mm	长度(L) mm	铍青铜(Be-Cu) g	铝青铜(Al-Cu) g
TL314C-0180	180*290	1400	1470	1270

TL314D 防爆火棉叉子

Fork For Gun Cotton



规格及主要技术参数

产品代号 Number	规格(T) mm	长度(L) mm	铍青铜(Be-Cu) g	铝青铜(Al-Cu) g
TL314D-0090	90*140	1000	800	600
TL314D-0150	150*250	1000	1480	1300

TL315 防爆便携式听针

Portable Hearing Needle



规格及主要技术参数

产品代号 Number	规格(T) mm	长度(L) mm	铍青铜(Be-Cu) g	铝青铜(Al-Cu) g
TL315-0600	600	600	300	260

TL315A 防爆除锈针

Needle



规格及主要技术参数

产品代号 Number	规格(T) mm	长度(L) mm	铍青铜(Be-Cu) g	铝青铜(Al-Cu) g
TL315A-0180	180	180	12	10

TL316 防爆消防桶

Fire Pail

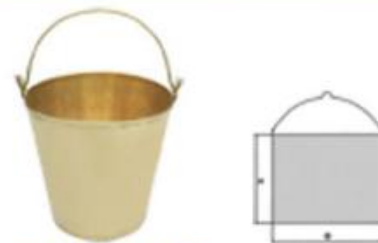

规格及主要技术参数

产品代号 Number	规格(S) mm	长度(L) mm	铍青铜(Be-Cu) g	铝青铜(Al-Cu) g
TL316-0318	318*250	318	1680	1460



TL317 铝消防桶

Fire Aluminum Drum



规格及主要技术参数

产品代号 Number	规格(S) mm	长度(L) mm	铝(Aluminum) g
TL317-0318	318*250	318	740

TL320 防爆漏斗

Oil Funnel



规格及主要技术参数

产品代号 Number	规格(S) mm	长度(L) mm	铍青铜(Be-Cu) g	铝青铜(Al-Cu) g
TL320-0180	180	180	280	255
TL320-0220	220	220	340	305
TL320-0260	260	260	460	415

TL318 防爆油桶

Bucket

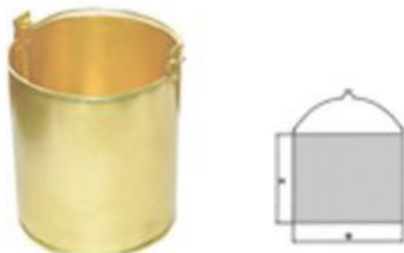

规格及主要技术参数

产品代号 Number	规格(S) mm	长度(L) mm	铍青铜(Be-Cu) g	铝青铜(Al-Cu) g
TL318-0300	300*250	300	1720	1515

TL321 铝油漏斗

Aluminum Oil Funnel



规格及主要技术参数

产品代号 Number	规格(S) mm	长度(L) mm	铝(Aluminum) g
TL321-0180	180	180	150
TL321-0220	220	220	180
TL321-0260	260	260	205

TL319 铝油桶

Aluminum Oil Bucket

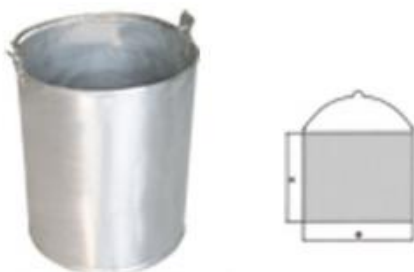

规格及主要技术参数

产品代号 Number	规格(S) mm	长度(L) mm	铝(Aluminum) g
TL319-0300	300*250	300	780

TL322 防爆接油盆

Oil Pans



规格及主要技术参数

产品代号 Number	规格(T) mm	长度(L) mm	铍青铜(Be-Cu) g	铝青铜(Al-Cu) g
TL322-0600	600*450*80	600	2750	2450



TL323 铝制接油盆

Aluminum Oil Pans



规格及主要技术参数

产品代号 Number	规格(S) mm	长度(L) mm	铝(Aluminum) g
TL323-0600	600*450*80	600	1300

TL326 防爆手电筒

Explosion-proof Torch



规格及主要技术参数

产品代号 Number	规格 mm	长度(L) mm	重量 g
TL326	三节270	250	120

TL324 防爆油瓢

Oil Ladle



规格及主要技术参数

产品代号 Number	规格(T) mm	长度(L) mm	铍青铜(Be-Cu) g	铝青铜(Al-Cu) g
TL324-0300	170*80*300	300	580	510

TL327 防爆探照手电

Explosion-proof Torch



规格及主要技术参数

产品代号 Number	规格 mm	长度(L) mm	重量 g
TL327	手提探照充电	200	1300

TL325 铝制油瓢

Aluminum Oil Ladle



规格及主要技术参数

产品代号 Number	规格(S) mm	长度(L) mm	铝(Aluminum) g
TL325-0300	170*80*300	300	240

TL328 防爆强光手电筒

Explosion-proof Torch



规格及主要技术参数

产品代号 Number	规格 mm	长度(L) mm	重量 g
TL328	强光充电	150	900



TL329 防爆斜铁



Angle Iron



规格及主要技术参数

产品代号 Number	规格(S) mm	长度(L) mm	铍青铜(Be-Cu) g	铝青铜(Al-Cu) g
TL329-1010	100*50*10	100	201	185
TL329-1510	150*50*10	150	260	230
TL329-1515	150*50*15	150	430	385
TL329-1520	150*50*20	150	460	425
TL329-1815	180*50*15	180	650	600
TL329-1820	180*50*20	180	710	650
TL329-2020	200*50*20	200	751	685
TL329-2030	200*50*30	200	1130	1015
TL329-2520	250*50*20	250	1230	1125
TL329-2530	250*50*30	250	1520	1340

TL329A 防爆缝隙斜铁



Space Wedge



规格及主要技术参数

产品代号 Number	规格(T) mm	长度(L) mm	铍青铜(Be-Cu) g	铝青铜(Al-Cu) g
TL329A-0250	5*50*250	250	246	205

TL329B 防爆L型斜铁



Nosekey



规格及主要技术参数

产品代号 Number	规格(T) mm	长度(L) mm	铍青铜(Be-Cu) g	铝青铜(Al-Cu) g
TL329B-0020	20*40*340	340	3016	2600
TL329B-0030	30*40*340	340	3248	2800
TL329B-0040	30*40*400	400	3850	3300

TL329C 防爆开石斜铁



Stone Wedge



规格及主要技术参数

产品代号 Number	规格(T) mm	长度(L) mm	铍青铜(Be-Cu) g	铝青铜(Al-Cu) g
TL329C-0120	44*120	120	1276	1100
TL329C-0150	45*150	150	1624	1400
TL329C-0190	47*190	190	2320	2000
TL329C-0240	50*240	240	3480	3000

TIANLONG 天龙防爆工具
高精品质 全国领先品牌



钢制工具系列

专业制造商

TIANLONG

TIANLONG



TL2201 敲击呆扳手

Wrench, Striking Open



规格及主要技术参数

产品代号 Number	规格(S) mm	长度(L) mm	重量 g
TL2201-22	22	135	190
TL2201-24	24	150	230
TL2201-27	27	175	390
TL2201-30	30	190	500
TL2201-32	32	190	540
TL2201-36	36	210	700
TL2201-38	38	220	820
TL2201-41	41	230	900
TL2201-46	46	250	1200
TL2201-50	50	275	1400
TL2201-55	55	305	1800
TL2201-60	60	315	2110
TL2201-65	65	335	2850
TL2201-70	70	370	3550
TL2201-75	75	375	4000
TL2201-80	80	400	5500
TL2201-85	85	400	5200
TL2201-90	90	445	7000
TL2201-100	100	485	10500
TL2201-110	110	512	13200
TL2201-120	120	530	16000
TL2201-130	130	560	18000
TL2201-140	140	630	24000
TL2201-150	150	630	23800

产品代号 Number	规格(S) mm	长度(L) mm	重量 g
TL2201-1002	7/8	135	190
TL2201-1004	15/16	150	230
TL2201-1006	1	175	390
TL2201-1008	1-1/8	190	500
TL2201-1010	1-1/4	190	540
TL2201-1012	1-7/16	210	700
TL2201-1014	1-1/2	220	820
TL2201-1016	1-5/8	230	900
TL2201-1018	1-3/4	250	1200
TL2201-1020	2	275	1400
TL2201-1022	2-1/8	305	1800
TL2201-1024	2-3/8	315	2110
TL2201-1026	2-1/2	335	2850
TL2201-1028	2-3/4	370	3550
TL2201-1030	3	375	4000
TL2201-1032	3-1/8	400	5500
TL2201-1036	3-1/2	445	7000
TL2201-1038	4	485	10500

TL2202 敲击梅花扳手

Wrench, Striking Box



规格及主要技术参数

产品代号 Number	规格(S) mm	长度(L) mm	重量 g
TL2202-17	17	145	200
TL2202-19	19	145	190
TL2202-22	22	155	230
TL2202-24	24	165	220
TL2202-27	27	175	330
TL2202-30	30	185	450
TL2202-32	32	185	440
TL2202-36	36	205	550
TL2202-41	41	225	710
TL2202-46	46	235	900
TL2202-50	50	250	1200
TL2202-55	55	265	1360
TL2202-60	60	274	1500
TL2202-65	65	298	1900
TL2202-70	70	320	2300
TL2202-75	75	326	2850
TL2202-80	80	350	3400
TL2202-85	85	355	4100
TL2202-90	90	380	5200
TL2202-100	100	410	6700
TL2202-110	110	445	8640
TL2202-120	120	480	10400
TL2202-130	130	520	11900
TL2202-140	140	520	12280
TL2202-150	150	565	13650
TL2202-160	160	585	15800

产品代号 Number	规格(S) mm	长度(L) mm	重量 g
TL2202-1002	7/8	155	230
TL2202-1004	15/16	165	220
TL2202-1006	1	175	330
TL2202-1008	1-1/8	185	450
TL2202-1010	1-1/4	185	440
TL2202-1012	1-7/16	205	550
TL2202-1014	1-1/2	215	225
TL2202-1016	1-5/8	225	710
TL2202-1018	1-3/4	235	900
TL2202-1020	2	250	1200
TL2202-1022	2-1/8	265	1360
TL2202-1024	2-3/8	274	1500
TL2202-1026	2-1/2	298	1900
TL2202-1028	2-3/4	320	2300
TL2202-1030	3	326	2850
TL2202-1032	3-1/8	350	3400
TL2202-1036	3-1/2	380	5200
TL2202-1038	4	410	6700



TL2203 弯柄敲击呆扳手

Wrench, Bent Striking Open



规格及主要技术参数

产品代号 Number	规格(S) mm	长度(L) mm	重量 g	产品代号 Number	规格(S) mm	长度(L) mm	重量 g
TL2203-19	19	140	140	TL2203A-50	50	275	1700
TL2203-22	22	150	170	TL2203A-55	55	305	2300
TL2203-24	24	150	200	TL2203A-60	60	315	2800
TL2203-27	27	175	400	TL2203A-65	65	335	3600
TL2203-32	32	190	550	TL2203A-70	70	370	4400
TL2203-36	36	210	750	TL2203A-75	75	375	4700
TL2203-41	41	230	1100	TL2203A-80	80	400	6100
TL2203-46	46	250	1250				

TL2204 弯柄敲击梅花扳手

Wrench, Bent Striking Box



规格及主要技术参数

产品代号 Number	规格(S) mm	长度(L) mm	重量 g	产品代号 Number	规格(S) mm	长度(L) mm	重量 g
TL2204-22	22	140	220	TL2204A-46	46	240	1100
TL2204-24	24	160	280	TL2204A-50	50	255	1300
TL2204-27	27	175	350	TL2204A-55	55	270	1500
TL2204-30	30	190	500	TL2204A-60	60	285	2000
TL2204-32	32	190	450	TL2204A-65	65	300	2500
TL2204-36	36	210	600	TL2204A-70	70	320	2800
TL2204-41	41	225	850	TL2204A-75	75	330	3200

TL2205 单头呆扳手

Wrench, Single Open End



规格及主要技术参数

产品代号 Number	规格(S) mm	长度(L) mm	重量 g	产品代号 Number	规格(S) mm	长度(L) mm	重量 g
TL2205-14	14	140	90	TL2205A-60	60	490	2000
TL2205-17	17	160	100	TL2205A-65	65	530	2800
TL2205-19	19	170	120	TL2205A-70	70	570	3050
TL2205-22	22	195	160	TL2205A-75	75	610	3500
TL2205-24	24	220	180	TL2205A-80	80	645	4600
TL2205-27	27	240	270	TL2205A-85	85	690	5200
TL2205-30	30	260	300	TL2205A-90	90	850	6100
TL2205-32	32	275	380	TL2205A-95	95	850	6100
TL2205-34	34	290	470	TL2205A-100	100	1000	7700
TL2205-36	36	310	500	TL2205A-105	105	1000	7700
TL2205-41	41	345	580	TL2205A-110	110	1000	9000
TL2205-46	46	375	900	TL2205A-115	115	1000	9000
TL2205-50	50	410	1150	TL2205A-120	120	1000	9500
TL2205-55	55	450	1400	TL2205A-125	125	1000	9500

TL2206 单头梅花扳手

Wrench, Single Open End Box



规格及主要技术参数

产品代号 Number	规格(S) mm	长度(L) mm	重量 g	产品代号 Number	规格(S) mm	长度(L) mm	重量 g
TL2206-22	22	190	170	TL2206-55	55	445	1830
TL2206-24	24	215	210	TL2206-60	60	474	2180
TL2206-27	27	230	265	TL2206-65	65	510	2600
TL2206-30	30	255	370	TL2206-70	70	555	3050
TL2206-32	32	265	445	TL2206-75	75	590	3085
TL2206-36	36	295	600	TL2206-80	80	620	4200
TL2206-41	41	330	835	TL2206-85	85	620	4800
TL2206-46	46	365	1135	TL2206-90	90	650	5400
TL2206-50	50	400	1400	TL2206-100	100	650	6100

TL2207 弯柄呆扳手

Wrench, Bent Single Open



规格及主要技术参数

产品代号 Number	规格(S) mm	长度(L) mm	重量 g	产品代号 Number	规格(S) mm	长度(L) mm	重量 g
TL2207-14	14	140	90	TL2207-60	60	490	2000
TL2207-17	17	160	100	TL2207-65	65	530	2800
TL2207-19	19	170	120	TL2207-70	70	570	3050
TL2207-22	22	195	160	TL2207-75	75	610	3500
TL2207-24	24	220	180	TL2207-80	80	645	4600
TL2207-27	27	240	270	TL2207-85	85	690	5200
TL2207-30	30	260	300	TL2207-90	90	850	6100
TL2207-32	32	275	380	TL2207-95	95	850	6100
TL2207-34	34	290	470	TL2207-100	100	1000	7700
TL2207-36	36	310	500	TL2207-105	105	1000	7700
TL2207-41	41	345	580	TL2207-110	110	1000	9000
TL2207-46	46	375	900	TL2207-115	115	1000	9000
TL2207-50	50	410	1150	TL2207-120	120	1000	9500
TL2207-55	55	450	1400	TL2207-125	125	1000	9500

TL2208 弯柄梅花扳手

Wrench, Single Bent Box



规格及主要技术参数

产品代号 Number	规格(S) mm	长度(L) mm	重量 g	产品代号 Number	规格(S) mm	长度(L) mm	重量 g
TL2208-10	10	119	55	TL2208-36	36	307	600
TL2208-12	12	151	82	TL2208-41	41	340	780
TL2208-14	14	151	90	TL2208-46	46	370	1050
TL2208-17	17	174	150	TL2208-50	50	400	1580
TL2208-19	19	207	215	TL2208-55	55	430	2130
TL2208-22	22	207	215	TL2208-60	60	450	2430
TL2208-24	24	250	330	TL2208-65	65	470	3520
TL2208-27	27	250	330	TL2208-70	70	490	3480
TL2208-30	30	295	520	TL2208-75	75	510	3800
TL2208-32	32	295	550	TL2208-80	80	530	4200



TL2209 高颈撬棒呆扳手

Wrench, Construction with Pin



规格及主要技术参数

产品代号 Number	规格(S) mm	长度(L) mm	重量 g	产品代号 Number	规格(S) mm	长度(L) mm	重量 g
TL2209-17	17	320	205	TL2209-32	32	400	755
TL2209-19	19	350	200	TL2209-36	36	430	900
TL2209-22	22	350	410	TL2209-41	41	470	1205
TL2209-24	24	370	450	TL2209-46	46	500	1515
TL2209-27	27	370	610	TL2209-50	50	530	1780
TL2209-30	30	400	755	TL2209-55	55	560	2045

TL2210 高颈撬棒梅花扳手

Wrench, Construction



规格及主要技术参数

产品代号 Number	规格(S) mm	长度(L) mm	重量 g	产品代号 Number	规格(S) mm	长度(L) mm	重量 g
TL2210-17	17	310	190	TL2210-55	55	560	2100
TL2210-19	19	330	215	TL2210-60	60	610	2500
TL2210-22	22	350	275	TL2210-65	65	630	2700
TL2210-24	24	370	340	TL2210-70	70	630	3200
TL2210-27	27	400	425	TL2210-75	75	665	3460
TL2210-30	30	430	600	TL2210-80	80	690	4000
TL2210-32	32	430	580	TL2210-85	85	690	3850
TL2210-36	36	460	825	TL2210-90	90	710	5000
TL2210-41	41	490	1070	TL2210-95	95	710	4800
TL2210-46	46	520	1450	TL2210-100	100	730	5800
TL2210-50	50	540	1780	TL2210-110	110	750	7200

TL2211 加力杆梅花扳手

Ring Wrench For Extension



规格及主要技术参数

产品代号 Number	规格(S) mm	长度(L) mm	重量 g
TL2211-24	24	180	450
TL2211-27	27	190	500
TL2211-30	30	200	550
TL2211-32	32	235	750
TL2211-36	36	245	850
TL2211-41	41	265	1000
TL2211-46	46	280	1400
TL2211-50	50	290	1600
TL2211-55	55	300	1750
TL2211-60	60	345	2800
TL2211-65	65	355	3200
TL2211-70	70	365	3700
TL2211-75	75	375	4100
TL2211-80	80	385	4900

TL2212 加力杆

Extension For TL2211



规格及主要技术参数

产品代号 Number	规格(φ) mm	长度(L) mm	重量 g
TL2212-2430	19	460	775
TL2212-3241	22	610	1130
TL2212-4655	25	760	1875
TL2212-6080	30	860	2880

TL2213 美式敲击梅花扳手

Offset Slogging Box Wrench(American Type)



规格及主要技术参数

产品代号 Number	规格(S) mm	长度(L) mm	重量 g	产品代号 Number	规格(S) mm	长度(L) mm	重量 g
TL2213-22	22	240	900	TL2213-75	75	420	5500
TL2213-24	24	240	900	TL2213-80	80	440	6900
TL2213-27	27	270	1200	TL2213-85	85	460	7330
TL2213-30	30	280	1400	TL2213-90	90	480	8800
TL2213-32	32	290	1600	TL2213-95	95	480	8800
TL2213-36	36	300	1800	TL2213-100	100	515	10900
TL2213-38	38	300	1700	TL2213-105	105	515	10900
TL2213-41	41	320	2000	TL2213-110	110	550	12100
TL2213-46	46	340	2600	TL2213-115	115	550	12100
TL2213-50	50	350	3000	TL2213-120	120	585	15200
TL2213-55	55	360	3900	TL2213-125	125	585	15100
TL2213-60	60	375	4100	TL2213-130	130	620	17800
TL2213-65	65	390	4200	TL2213-135	135	620	17650
TL2213-70	70	400	5100				



TL2214 风动套筒头

Wrench, Combination



◆ 1-1/2" 风动套筒头

规格及主要技术参数

产品代号 Number	规格(S) mm	长度(L) mm	重量 g	产品代号 Number	规格(S) mm	长度(L) mm	重量 g
TL2214-32	32	75	1860	TL2214-95	95	110	5500
TL2214-36	36	80	2200	TL2214-100	100	115	5820
TL2214-41	41	80	2150	TL2214-105	105	115	6400
TL2214-46	46	85	2290	TL2214-110	110	115	6540
TL2214-50	50	85	2380	TL2214-115	115	125	10380
TL2214-55	55	90	2480	TL2214-120	120	125	11020
TL2214-60	60	90	2640	TL2214-125	125	130	11970
TL2214-65	65	95	3060	TL2214-130	130	135	13575
TL2214-70	70	95	3200	TL2214-135	135	140	14850
TL2214-75	75	100	3625	TL2214-140	140	140	15600
TL2214-80	80	100	3980	TL2214-145	145	145	13800
TL2214-85	85	110	4400	TL2214-150	150	150	19500
TL2214-90	90	110	4700				

◆ 加深1-1/2" 风动套筒头

规格及主要技术参数

产品代号 Number	规格(S) mm	长度(L) mm	重量 g	产品代号 Number	规格(S) mm	长度(L) mm	重量 g
TL2214A-41	41	115	3000	TL2214A-90	90	178	7680
TL2214A-46	46	115	3300	TL2214A-95	95	184	8850
TL2214A-50	50	135	3400	TL2214A-100	100	190	9080
TL2214A-55	55	140	3930	TL2214A-105	105	197	13200
TL2214A-60	60	150	4790	TL2214A-110	110	203	14030
TL2214A-65	65	150	5440	TL2214A-115	115	203	10670
TL2214A-70	70	160	6000	TL2214A-120	120	213	19000
TL2214A-75	75	170	6250	TL2214A-125	125	213	20020
TL2214A-80	80	170	6390	TL2214A-130	130	220	22500
TL2214A-85	85	170	7130				

◆ 1" 风动套筒头

规格及主要技术参数

产品代号 Number	规格(S) mm	长度(L) mm	重量 g	产品代号 Number	规格(S) mm	长度(L) mm	重量 g
TL2214B-30	30	60	750	TL2214B-55	55	75	1680
TL2214B-32	32	60	760	TL2214B-60	60	85	2100
TL2214B-36	36	65	900	TL2214B-65	65	85	2170
TL2214B-41	41	70	940	TL2214B-70	70	90	2500
TL2214B-46	46	75	1300	TL2214B-75	75	90	2780
TL2214B-50	50	75	1500	TL2214B-80	80	90	3000

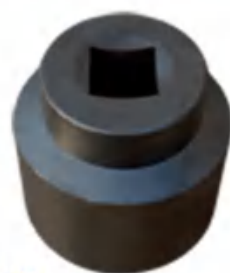

◆ 3/4" 风动套筒头

规格及主要技术参数

产品代号 Number	规格(S) mm	长度(L) mm	重量 g
TL2214C-24	24	50	315
TL2214C-27	27	50	345
TL2214C-30	30	55	445
TL2214C-32	32	55	490
TL2214C-36	36	60	530
TL2214C-41	41	60	725
TL2214C-46	46	70	825
TL2214C-50	50	70	950

◆ 1" 手动套筒头

规格及主要技术参数

产品代号 Number	规格(S) mm	长度(L) mm	重量 g
TL2214D-24	24	100	950
TL2214D-27	27	100	1000
TL2214D-30	30	100	1000
TL2214D-32	32	100	1200
TL2214D-36	36	100	1200
TL2214D-38	38	100	1400
TL2214D-41	41	100	1550
TL2214D-46	46	100	2120
TL2214D-50	50	100	2380
TL2214D-55	55	100	2730
TL2214D-60	60	100	2800
TL2214D-65	65	100	2950
TL2214D-70	70	100	3120
TL2214D-75	75	100	3600
TL2214D-80	80	100	4000

◆ 3/4" 手动套筒头

规格及主要技术参数

产品代号 Number	规格(S) mm	长度(L) mm	重量 g	产品代号 Number	规格(S) mm	长度(L) mm	重量 g
TL2214E-17	17	90	570	TL2214E-34	34	90	830
TL2214E-19	19	90	580	TL2214E-36	36	90	890
TL2214E-22	22	90	600	TL2214E-38	38	90	980
TL2214E-24	24	90	650	TL2214E-41	41	90	1000
TL2214E-27	27	90	650	TL2214E-46	46	100	1300
TL2214E-30	30	90	750	TL2214E-50	50	100	1660
TL2214E-32	32	90	800				

TIANLONG 天龙防爆工具
高精品质 全国领先品牌



防爆组合系列

专业制造商

TIANLONG

TIANLONG

防爆盒装套筒1/4" *3/8" >

Dr Socket Set1/4" *3/8"



规格及主要技术参数

TL330防爆1/4" 方9件套盒装套筒 1/4" Dr Socket Set-9Pcs	
TL330	套筒4,5,5,5,6,7,8,9,10, 旋具手柄
TL331防爆3/8" 方10件套盒装套筒 3/8" Dr Socket Set-10Pcs	
TL331	10,11,12,13,14,17,19,13/16" 火花塞套筒, 200棘轮扳手, 75接杆
TL332防爆1/4" *3/8" 方20件套盒装套筒 1/4" *3/8" Dr Socket Set-20Pcs	
TL332	1,4,5,5,5,5,6,7,8, (1/4") 10,11,12,13,14,15,17,19(3/8") 13/16" 火花塞套筒, 200棘轮扳手, 75旋柄, 100接杆, 直接头3/8" *1/4" 接头

防爆盒装套筒1/2" (inch) >

Dr Socket Set1/2" (inch)



规格及主要技术参数

TL333防爆1/2方17件套盒装套筒 (英制)	
TL333	3/8" ,7/16" ,1/2" ,9/16" ,5/8" ,11/16" ,3/4" ,13/16" ,7/8" ,15/16" ,1" 换向棘轮扳手, 250滑行头手柄, 420快速摇柄, 75万向接头, 125, 20接杆
TL334防爆1/2方23件套盒装套筒 (英制)	
TL333	5/16" ,3/8" ,7/16" ,1/2" ,9/16" ,11/16" ,3/4" ,13/16" ,7/8" ,15/16" ,1" ,1/16" ,1-1/8" ,1-1/4" 换向棘轮扳手, 250滑行头手柄, 420快速摇柄, 75万向接头, 125, 125,250接杆, 52旋具接头, 250转向手柄

防爆盒装套筒1/2" >

Dr Socket Set1/2"



规格及主要技术参数

TL335防爆1/2" 方9件套盒装套筒 1/2" Dr Socket Set-9Pcs	
TL335	10,11,12,14,17,19,22,24,225弯柄
TL336防爆1/2" 方13件套盒装套筒 1/2" Dr Socket Set-13Pcs	
TL336	10,11,12,14,17,19,22,24,27,250棘轮扳手,
TL337防爆1/2" 方24件套盒装套筒 1/2" Dr Socket Set-24Pcs	
TL337	10,11,12,13,14,16,17,18,19,20,22,23,24,26,27,28,30,32mm,250棘轮扳手、250滑行头手柄、420快速摇柄、125、250接杆, 75万向接头、直接头
TL338防爆1/2" 方28件套盒装套筒 1/2" Dr Socket Set-28Pcs	
TL338	10,11,12,13,14,15,16,17,18,19,20,21,22,23,24,26,27,28,30,32,250棘轮扳手, 250滑行头手柄, 420快速摇杆, 125、250接杆, 75万向接头, 52旋具接头, 直接头
TL339防爆1/2" 方32件套盒装套筒 1/2" Dr Socket Set-32Pcs	
TL339	8,9,10,11,12,13,14,15,16,17,18,19,20,21,22,23,24,26,27,28,30,32mm,13/16" 火花塞套筒, 250棘轮扳手、直接头、250滑行头手柄、420快速摇柄、230弯柄、125、250接杆、75万向接头、52旋具接头

防爆盒装套筒3/4" *1" >

Dr Socket Set3/4" *1"



规格及主要技术参数

TL340防爆3/4" 方21件套盒装套筒
3/4" Dr Socket Set-21Pcs

TL340	19,21,22,23,24,26,27,28,30,32,34,36,38,41,46,50棘轮扳手, 长接杆, 短接杆, 滑行头手柄, 直接头
-------	---

TL341防爆3/4" *1" 方26件套盒装套筒
3/4" *1" Dr Socket Set-26Pcs

TL341	21,22,23,24,26,27,28,29,30,31,32,34,36,38,41,46,50(3/4") 55,60,65(1") mm, 125棘轮扳手、200接杆、525滑行头手柄、525加力杆、83大滑行头、直接头
-------	--

TL342防爆1" 方21件套盒装套筒
1" Dr Socket Set-21Pcs

TL342	30,31,32,34,36,38,41,46,50,55,60,65,70,75,80,125棘轮扳手头, 220接杆, 525滑行头手柄, 525加力杆, 135万向接头, 直接头
-------	--

TL343防爆电工五联包 >

Electrical Five Package



规格及主要技术参数

TL343	活扳手8"、克丝钳8"、尖嘴钳6"、电工刀120、一字螺丝刀100、十字螺丝刀100
-------	--

TL344防爆电工组合工具32件套 >

Electrician Tools Set-32Pcs



规格及主要技术参数

TL344	防爆螺丝刀(十字一字)75,100 防爆锯弓子500 防爆锯条300 防爆鲤鱼钳200 防爆克丝钳200 防爆尖嘴钳160 防爆活扳手250 防爆电工刀125 防爆检验锤0.25kg 防爆内六角4,5,6,8,10 防爆双头呆6*7,8*10,9*11,10*12,12*14,14*17,17*19 防爆双头梅花6*7,8*10,9*11,10*12,12*14,14*17,17*19 防爆镊子
-------	---

TL345防爆天然气专用工具20件套 >

Tool Set For Nature Gas,20Pcs



规格及主要技术参数

TL345	<p>双头呆扳手8*10,10*12,12*14,14*17,17*19,双头梅花扳手8*10,10*12,12*14,14*17,17*19,活扳手250,检验锤0.25kg,克丝钳200,管钳200,尖嘴钳150,镊子150,一字螺丝刀100,150,十字螺丝刀100,150</p>
-------	--

TL346A防爆油库专用工具25件套 >

Tool Set For Oil Depot Overhauling,25Pcs



规格及主要技术参数

TL346A	<p>两用扳手8,10,12,14,17,19,22,活扳手200,250,克丝钳200,尖嘴钳160,鲤鱼钳200,斜嘴钳160,旋具100,150(-)(+),扁铲180,凿子180,圆头锤0.45,管钳300,F扳手300,弧形除锈铲75,撬杠400,手电筒,铝扣箱</p>
--------	--

TL346防爆油库检修工具42件套 >

Tool Set For Oil Depot Overhauling,42Pcs



规格及主要技术参数

TL346	<p>双头呆扳手8*10,9*11,12*14,14*17,16*18,17*19,19*22,22*24,24*27,双头梅花12*14,14*17,16*18,17*19,19*22,22*24,24*27,活扳手24*200,36*300,46*375,奶头锤2P,撬棍18*500,泥子刀55*200,管钳250,300,鲤鱼钳200,克丝钳200,一字螺丝刀75,100,150,十字螺丝刀75,100,150,双头除锈刮刀350,铜丝刷4行,扁铲300,听棒300,镊子150,万能扳手10-30,F型扳手250,350,单头开桶扳手300,弧形除锈铲75</p>
-------	--

TL346B防爆油库专用工具36件套 >

Tool Set For Oil Depot Overhauling,36Pcs



规格及主要技术参数

TL346B	<p>两用扳手8,10,12,14,17,19,22,24,27,30,内六角4,5,6,8,10,活扳手200,250,克丝钳200,尖嘴钳160,鲤鱼钳200,斜嘴钳160,旋具100,150,200(-)(+),扁铲180,凿子180,圆头锤0.68,管钳350,F扳手300,除锈铲75,弧形铲75,撬杠400,手电筒,铝扣箱</p>
--------	---

TL347防爆加油站工具22件套

Tool Set For Gas Station, 22Pcs



规格及主要技术参数

TL347

双头呆扳手8*10, 10*12, 12*14, 14*17, 16*18, 17*19, 19*22双头梅花扳手8*10, 10*12, 12*14, 14*17, 16*18, 17*19, 19*22活扳手250, 克丝钳200, 管钳250, 尖嘴钳150, 一字螺丝刀100, 150, 十字螺丝刀100, 150

TL348防爆矿山抢险专用工具28件套

Tool Set For Mine Rescue, 28Pcs



规格及主要技术参数

TL348

撬棒梅花扳手17, 19, 22, 24, 27, 30, 32, 34, 36, 活扳手200, 250, 300, 管钳200, 250, 300, 撬棍20*600, 检验锤0.25kg, 八角锤3.6kg, 奶头锤0.9kg, 斧子0.7kg, F型扳手400, 万能扳手15-40, 一字螺丝刀150, 十字螺丝刀150, 镐头450, 扁铲20*300, 两用锹, 除锈铲55

TL347A防爆加油站专用工具25件套

Tool Set For Gas Station, 25Pcs



规格及主要技术参数

TL347A

两用扳手10, 12, 14, 17, 19, 22, 内六角4, 5, 6, 8, 10, 活扳手200, 250, 克丝钳200, 尖嘴钳160, 鲤鱼钳200, 斜嘴钳160, 旋具100, 150(-)(+), 扁铲180, 凿子180, 圆头锤0.45, 手电筒, 铝扣箱

TL348A防爆组合工具28件套

Tool Set, 28Pcs



规格及主要技术参数

TL348A

防爆装柄八角锤1.8kg, 防爆装柄奶头锤0.91kg, 防爆装柄羊角锤0.45kg, 防爆管钳子300, 450, 防爆活扳手200, 300, 防爆呆梅两用扳手8, 10, 12, 14, 17, 19, 22, 24, 27, 30, 32, 防爆克丝钳200, 防爆尖嘴钳200, 防爆鲤鱼钳200, 防爆撬棍25*300, 防爆扁铲25*300, 防爆一字螺丝刀100, 200, 防爆十字螺丝刀100, 200, 防爆F型扳手400

TL348B防爆组合工具36件套

Tool Set ,36Pcs



规格及主要技术参数

TL348B	防爆装柄八角锤1.8kg, 防爆装柄奶头锤0.91kg, 防爆管钳子450, 防爆活扳手150,200, 防爆呆梅两用扳手10,8,防爆克丝钳200,150,防爆尖嘴钳150, 防爆鲤鱼钳200, 防爆圆嘴钳150, 防爆鸭嘴钳150, 防爆斜口钳150, 防爆一字螺丝刀75,100,150,200, 防爆十字螺丝刀75,100,150,200, 防爆S型螺丝刀6*72,8*125,10*196,防爆扁铲16*160, 防爆剪刀150, 防爆削皮刀250, 防爆泥子刀50, 防爆镊子200, 防爆撬棍19*500, 防爆T型钎子250, 防爆羊角起钉钳400, 防爆锯弓子500, 防爆锯条300, 防爆刷子290
--------	--

TL350防爆石油石化配套服务便民箱17件套

Petroleum And Petrochemical Industries service Facilities-Convenient Case



规格及主要技术参数

TL350	双头呆扳手8*10,9*11,12*14,14*17,17*19,活扳手24*200,30*250,克丝钳200, 尖嘴钳150, 鲤鱼钳200,奶头锤0.25kg,一字螺丝刀100,200, 十字螺丝刀100,200,毛刷2.5" ,电笔
-------	--

TL349防爆检修专用工具50件套

Tool Set For Inspection And Maintenance ,50Pcs



规格及主要技术参数

TL349	双头呆扳手8*10,9*11,10*12,12*14,14*17,17*19,19*22,22*24,24*27,27*30双头梅花扳手10*12,12*14,14*17,17*19,19*22,22*24,24*27,活扳手8" ,12" ,15" ,管钳10" ,18" ,奶头锤2.5P,撬棍20*600,鲤鱼钳8" ,克丝钳8" ,听针300,一字螺丝刀75,150,200,十字螺丝刀75,150,200,镊子150,扁铲20*300,两用锹,单头开桶扳手300,400,锯弓子500,手电LED,丝刷4行,双头除锈刮刀300,万能扳手10-30,镐头450,除锈铲55
-------	--

TL351防爆加气设备维修工具32件套

Gas Equipment Maintenance Tools



规格及主要技术参数

TL351	防爆两用扳手12,14,17,19,22,24,27-2套, 防爆管钳300,防爆内六角3,4,5,6,8,10,防爆活扳手200,防爆单头梅花30-2把,防爆螺丝刀一字150,250,防爆十字螺丝刀150,250,防爆尖嘴钳150,防爆内卡簧钳175,防爆外卡簧钳175
-------	--

TL352防爆组合工具车120件套



Composite Tools Covered-120 Pcs



规格及主要技术参数

TL351

防爆双梅：8-32（13件套） 防爆双呆：8-32（13件套） 防爆两用：8-32（13件套） 防爆套筒扳手：1/2寸 8-32（32件套） 防爆内六角：3,4,5,6,8,10,（6件套） 防爆螺丝刀十字：100,150,200,250 防爆螺丝刀一字：100,150,200,250 防爆F扳手：250,400 防爆八角锤：1kg,1.8kg 防爆羊角锤：0.5kg 防爆奶头锤：2P 防爆活扳手：150,200,250,300 防爆管钳：150,200,250,300,350 防爆克丝钳：200 防爆尖嘴钳：150 防爆斜口钳：150 防爆螺丝刀十字：100,150,200,250 防爆螺丝刀一字：100,150,200,250 防爆扁铲：16*18 防爆起钉器：300 防爆开桶扳手（双头）：350 防爆削皮刀：250 防爆泥子刀：200*75 防爆镊子：290 防爆锯弓子：500 防爆锯条：300 防爆检验锤：0.25kg 防爆两用刮刀：300 防爆鲤鱼钳：200 防爆剪子：150 防爆水泵钳：250 防爆撬棍：400 防爆钎子：180



河北省著名商标
Hebei Province Famous Brand

中国著名品牌
China Famous Brand

沧州天龙防爆工具有限公司

Cangzhou Tianlong Explosion-proof Tools Co.,Ltd

中国·河北省泊头市南付庄开发区

电话: 0317-8308055 8308056 8309979
8222221 8287772

传真: 0317-8285444

24小时服务热线: 15028612888

网址: www.non-sparking-tools.com

www.cztlfb.com

www.防爆工具.com

E-mail: info@cztlfb.com